

User's Manual

HT8322 series

PROGRAMMABLE DC ELECTRONIC LOAD

Content

| | |
|--|----|
| Contents 1 Introduction..... | 3 |
| Chapter 2 Size and Installation..... | 7 |
| Chapter 2 Quick Start..... | 10 |
| 2.1 Product Introduction..... | 10 |
| 2.2 Features..... | 10 |
| 2.3 Front Panel..... | 12 |
| 2.4 LCD Status Bar Function..... | 14 |
| 2.5 Rear Panel..... | 15 |
| 2.6 First turn-on checkout..... | 16 |
| 2.6.1 Self-test Process..... | 16 |
| 2.6.2 In the Event of a Problem..... | 17 |
| Chapter 3 Functions and Features..... | 18 |
| 3.1 Basic Operation Modes..... | 18 |
| 3.1.1 Constant Current Mode (CC)..... | 18 |
| 3.1.2 Constant Voltage Mode (CV)..... | 19 |
| 3.1.3 Constant Resistance Mode (CR)..... | 20 |
| 3.1.4 Constant Power Mode (CW)..... | 21 |
| 3.2 List Operation..... | 22 |
| 3.3 OCP Test Function..... | 26 |
| 3.4 EFFT Function..... | 28 |
| 3.5 Auto test function..... | 29 |
| 3.6 Dynamic Function..... | 34 |
| 3.7 Battery test function..... | 38 |
| 3.8 Short-circuit Simulation Function..... | 40 |
| 3.9 LED Simulation Function..... | 41 |
| 3.10 SWEEP dynamic frequency conversion scanning..... | 45 |
| 3.11 TIMING Time measurement..... | 47 |
| 3.12 Measurement item..... | 49 |
| 3.12.1 Voltage, current, resistance and power measurement..... | 49 |
| 3.12.2 Ripple measurement..... | 50 |
| Chapter 4 System settings and Save function..... | 51 |
| 4.1 System Settings..... | 51 |
| 4.1.1 Von/Voff Function..... | 52 |
| 4.1.2 Power Supply Type Selection Function..... | 53 |
| 4.2 Configuration..... | 53 |
| 4.2.1 Remote Sense Compensation Mode..... | 55 |
| 4.2.2 Shortcut Call Mode..... | 56 |
| 4.2.3 Trigger Output Settings..... | 57 |
| 4.3 Save Function..... | 57 |
| Chapter 5 Protection Function..... | 60 |
| 5.1 Over-voltage protection (OVP)..... | 60 |
| 5.2 Over-current protection (OCP)..... | 60 |
| 5.3 Over-power protection (OPP)..... | 61 |
| 5.4 Over-temperature protection (OTP)..... | 61 |
| 5.5 Input Voltage Reverse Protection (RV)..... | 62 |
| Chapter 6 I/O Interface..... | 63 |
| 6.1 I/O Interface..... | 63 |
| 6.2 I/O Interface Function..... | 63 |
| Chapter 7 Specifications..... | 65 |
| 7.1 Main Specifications..... | 65 |
| Chapter 8 Communication Interfaces..... | 67 |
| 8.1 Communication module..... | 67 |
| 8.2 DB9..... | 67 |
| 8.3 Protocol..... | 68 |
| 8.4 SCPI Communication Instruction..... | 69 |

Contents 1 Introduction

Thank you for purchasing Hopetech HT8XXX series DC Electronic Load. To obtain maximum performance from the product, please read this manual first, and keep it handy for future reference. We will use the alias E-load of DC Electronic Load in the following.

Registered trademarks

Windows and Excel are registered trademarks of Microsoft Corporation in the United States and/or other countries.

Checking Package Contents

When you receive the instrument, inspect it carefully to ensure that no damage occurred during shipping. In particular, check the accessories, panel switches, and connectors. If damage is evident, or if it fails to operate according to the specifications, contact your authorized Hopetech distributor or reseller.

When transporting the instrument, use the same packaging materials used for the delivery to you.

Check the package contents as follows

| No. | Item | Quantity |
|-----|--------------------|----------|
| 1 | DC Electronic Load | 1 |
| 2 | User's Manual | 1 |
| 3 | RS232 Cable | 1 |
| 4 | Power Cord | 1 |
| 5 | Test Report | 1 |
| | | |

Safety Notes

The instrument is designed to conform to IEC 61010 Safety Standards, and has been thoroughly tested for safety prior to shipment. However, using the instrument in a way not described in this manual may negate the provided safety features.

Before using the instrument, be certain to carefully read the following safety notes.

Note

Mishandling during use could result in injury or death, as well as damage to the instrument. Be certain that you understand the instructions and precautions in the manual before use.

Notation

This manual contains information and warnings essential for safe operation of the instrument and for maintaining it in safe operating condition. Before using the instrument, be certain to carefully read the following safety notes.



Indicates very important message in this manual. When the symbol is printed

on the instrument, refer to a corresponding topic in the Instruction Manual.



Indicates DC (direct current)



Indicates a fuse



Indicates earth terminal

In this manual, the risk seriousness and the hazard levels are classified as follows.

| | |
|----------------|---|
| WARNING | Indicates an imminently hazardous situation that will result in death or serious injury to the operator. |
| DANGER | Indicates a potentially hazardous situation that will result in death or serious injury to the operator. |
| CAUTION | Indicates a potentially hazardous situation that may result in minor or moderate injury to the operator or damage to the instrument or malfunction. |
| NOTE | Indicates functions of the instrument or relative suggestion of a correct operation. |

Usage Notes

Installation environment

- Operating temperature and humidity range
0°C ~ 40°C, < 80%RH(no condensation)
- Storage temperature and humidity range
23 ± 5°C 80%RH (no condensation)

Installing the instrument in inappropriate locations may cause a malfunction of instrument or accident.

Avoid the following locations.

- Exposed to direct sunlight or high temperature
- Exposed to corrosive or combustible gases
- Exposed to water, oil, chemicals, or solvents
- Exposed to high humidity or condensation
- Exposed to a strong electromagnetic field or electrostatic charge
- Exposed to high quantities of dust particles



- Near induction heating systems (such as high-frequency induction heating systems and IH cooking equipment)
- Susceptible to vibration

Checking before use

| | |
|--|---|
|  WARNING | <p>Before using the instrument, check that the coating of the test leads or cables are neither ripped nor torn and that no metal parts are exposed. Using the instrument under such conditions could result in electrocution. Contact your authorized Hopetech distributor or reseller in this case</p> |
|--|---|

Before using the instrument at the first time, verify that it operates normally to ensure that no damage occurred during storage or shipping. If you find any damage, contact your authorized Hopetech distributor or reseller.

Handling Precautions

| | |
|--|---|
|  DANGER | <p>Do not try to modify, disassemble, or repair the instrument. This may result in fire, electric shock accident, or injury.</p> |
|  CAUTION | <p>Do not place the instrument on an unstable or slanted surface. It may drop or fall, causing injury or instrument failure.</p> <p>This equipment is an electric energy conversion to heat equipment, blocking the ventilation holes of the equipment will lead to serious consequences.</p> |
|  NOTE | <p>Be sure to turn the power off after using it.</p> |

Measurement precautions

| | |
|---|--|
|  DANGER | <p>To avoid electric shock accident and short circuit, please operate the instrument as following:</p> <p>Do not test the voltage over 150 VDC</p> <p>Do not test the terminal-to-ground voltage over 160 VDC.</p> <p>Do not test AC voltage.</p> <p>Be sure to connect the test lead correctly.</p> |
|---|--|

| | |
|--|--|
| | Wear gloves of rubber or similar materials during measurement. |
|--|--|

| | |
|---|--|
|  NOTE | For achieving the measurement accuracy, it is recommended that the equipment should be operated half an hour after power-on. |
|---|--|

Chapter 2 Size and Installation

1.1 Dimension

HT8XXX series electronic load dimension

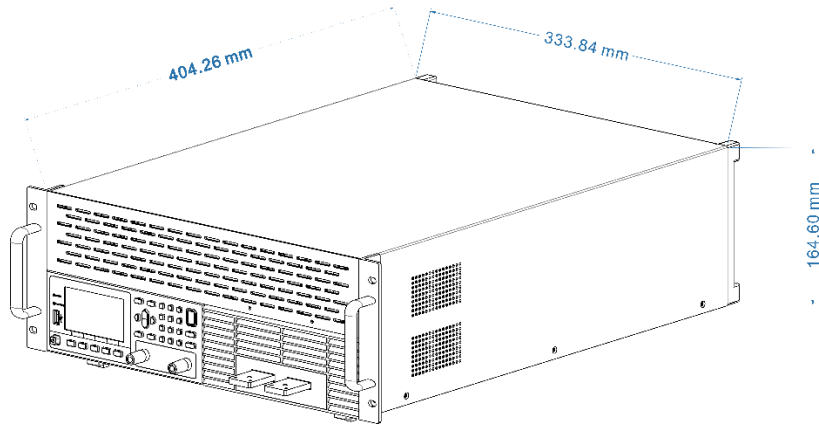

Figure 1.1 Instrument dimension

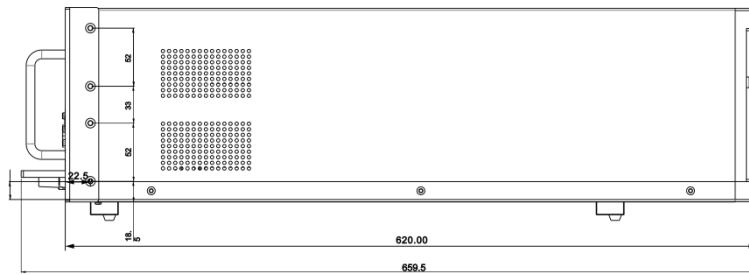

Figure 1.2 Instrument dimension 1

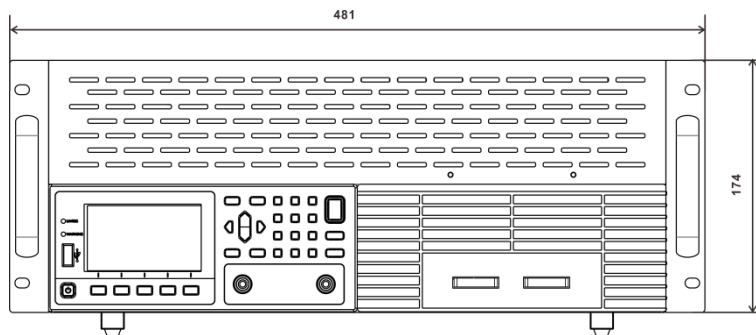

Figure 1.2 Instrument dimension 2

1.2 Angle adjustable

The HT8XXX series electronic load bracket is adjustable in angle and convenient for users to place.

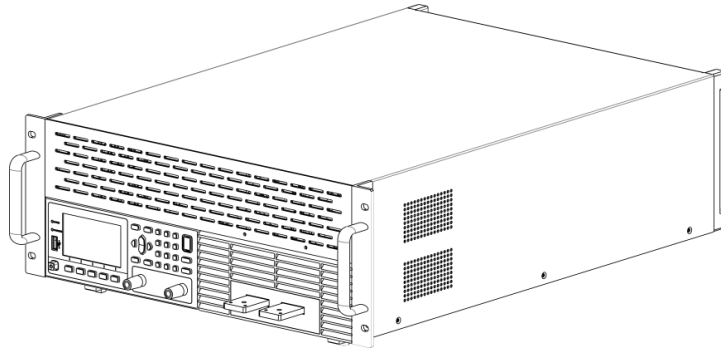

Figure 1.4 E-Load bracket open

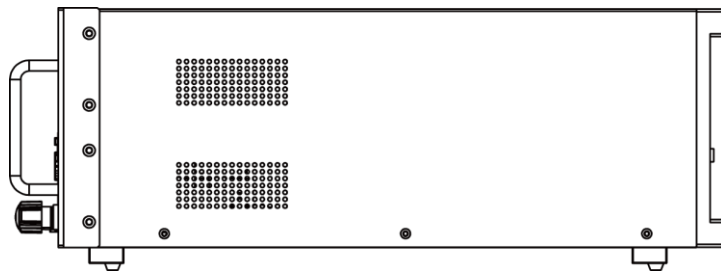

Figure 1.5 E-Load bracket close

1.3 Installation

This instrument is intended for indoor use in a pollution degree 2 environment. Please refer to the specifications table for the allowable environment operating limits.

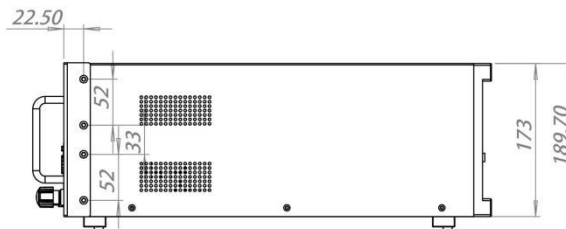

Figure 1.6 E-Load outline diagram unit (mm)

There are 2 cabinet mounting holes on the both sides of the E-load. After removing the gap, it can be used for cabinet installation and positioning.

1.4 Plug in Power Cord

Connect an appropriate IEC power cord to the DC Load and plug the power cord into an AC power outlet. Please find the following power cord type in different countries and areas.

Ensure that the line voltage selector switch on the back panel is set to match your line voltage. Failure to do so could result in damage to the instrument.

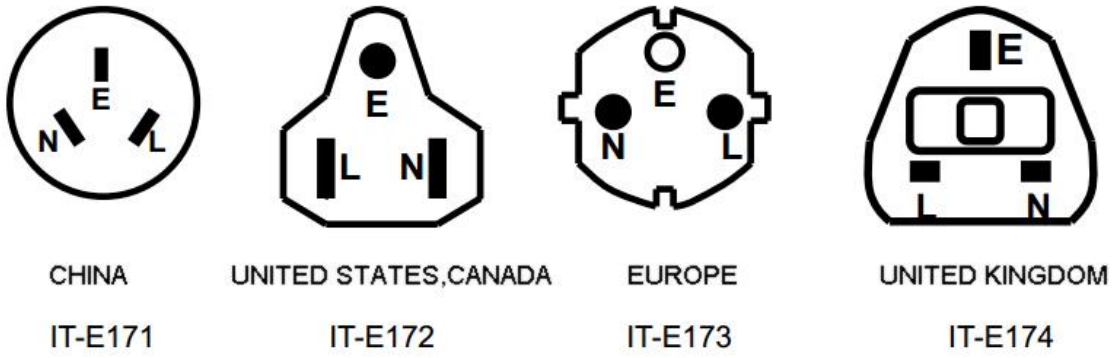

Figure 1.7 4 types of power cord for different countries and area

Chapter 2 Quick Start

This chapter describes the power-on check procedure for the HT8XXX Series load

to ensure that the E-load is properly started and used during initialization. It also introduces the E-load front panel, rear panel, keyboard button functions and LCD display function to ensure that you can quickly understand the appearance, structure and button usage of the E-load before operating the E-load.

2.1 Product Introduction

Basic specification

| | |
|--------------------|---------------|
| Model | HT8XXX |
| Max Voltage | 150V |
| Max Power | 1800W |
| Max Current | 240A |
| Channel | 1 |
| Resolution | 0.1mV / 0.1mA |

With dynamic, automatic test, LED, List, OCP, EFFECT, battery and short and many other test functions, HT8XXX series E-load is mainly used for battery, AC-DC, DC-DC modules, chargers and electronic components and other product performance testing. It provides a best solution for design development and production line testing.

HT8XXX series E-load supports RS232, RS485, and Ethernet communication interfaces to fit your versatile solution and testing needs.

2.2 Features

- 1) 24-bit true color LCD display (liquid crystal display), GUI operation interface;
- 2) 500kHz synchronous sampling, 10Hz, 0.1mV/0.01mA stable resolution output;

3) Four basic function modes:

- CV constant voltage mode
- CC constant current mode
- CW constant power mode
- CR constant resistance mode

4) Multiple extended function modes:

LIST mode

simulate a variety states of load change.

OCP mode

Over current protection point test mode.

EFFECT mode

Load effect test mode.

AUTO mode

5) Actual LED simulation to test LED power.

6) Voltage/current ripple test (V_{pp} , I_{pp});

7) Professional battery test function (BATTERY);

8)Dynamic Test Mode (DYNA);

9)High-speed dynamic frequency conversion scanning function (SWEEP)

10)Short circuit mode (SHORT);

11)Shortcut mode supports 10 sets of global data storage and reading (SHORTCUT);

12) No loading mode (OFF);

13) Support Von and Voff functions;

14) Remote compensation measurement mode (REMOTE);

15) Memory capacity up to 200*8 groups;

16) Intelligent fan system fan automatically initiated activate according based on changing to the ambient temperatures

17) Built-in Buzzer as an early warning reminder;

18) Power-off to maintain memory function;

19) USB port upgrade procedure;

20) Electrically isolated communication for I/O interface, RS232/485, NET network port;

2.3 Front Panel

The following picture is the front panel for the HT8XXX E-Load. All models have the same front panel, only the terminal section will vary based on the model.

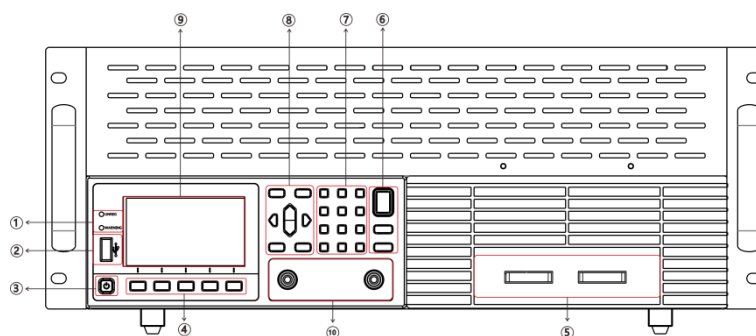









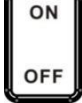

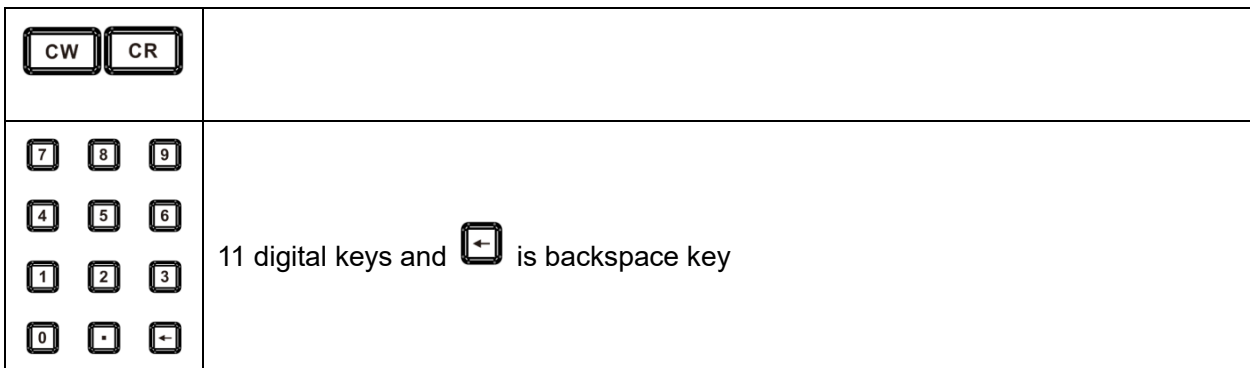

Figure 2.3 front panel

| Item | Description |
|------|--|
| 1 | Warning lights for loading failure or other warning states |
| 2 | U disk interface |
| 3 | Power-up key |
| 4 | Function keys |
| 5 | E-Load input terminal |
| 6 | Operating keys |
| 7 | Digital keys |
| 8 | Operating keys |
| 9 | LCD display panel |

Front panel key description

| | |
|---|--|
|  | When in the standby state, the panel POWER button light is red, press the POWER button for 3s, the power is turned on, the screen is lit, and the panel button light turns green. |
|  | In the working mode, press the key SET to set the parameters corresponding to the mode. |
|  | Long press to open/close the keyboard lock; when the status bar icon is  , all other keys are invalid. |
|  | When the E-load is in the working mode, press this key to select the expected load modes. |
|  | Press this key to switch the interface between load, system configuration, system parameter setting and loading the setting files. |
|  | In the working mode interface, adjust the cursor position and adjust the loading value. Move the status bar position on another interface. |
|  | Trigger the E-load in specific working mode |
|  | Confirm the selected value or enter the setting menu. |
|  | Cancellation of operation or moving back to the top menu. |
|  | Loading or unloading the load. |
|  | 4 basic working modes(CV/CC/CW/CR) shortcut keys. |



2.4 LCD Status Bar Function

The following screen is HT8XXX series E-load LCD display interface. The status bar is the top line icons. There are several icons on the status bar in the top line.

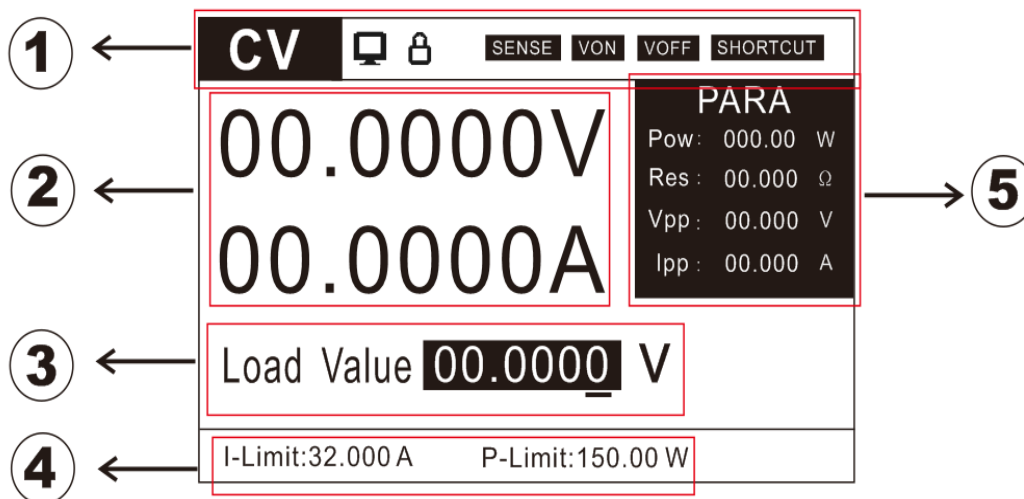





Figure 2.2 LCD display

| Item | Description |
|------|--|
| 1 | Instrument operating mode and status bar (described in the below table); |
| 2 | Readback value display |
| 3 | Present loading value edit box |
| 4 | E-load protection limit setting |
| 5 | E-load conversion parameter value display |

Status bar icon description

| | |
|--------------|--|
| SENSE | The remote compensation function is turned on. |
|--------------|--|

| | |
|---|--|
| | <p>Through the SENSE port at the rear panel of E-load, the output voltage of the power supply under test is collected.</p> <p>Using remote sensing, you can sense the voltage at the power supply's terminals, effectively removing the effect of the voltage drop in the connection wire.</p> |
| <p>VON</p> <p>VOFF</p> | <p>Loading automatically while start setup voltage > VON voltage</p> <p>Stop loading while shutdown voltage < Voff voltage</p> |
| SHORTCUT | Shortcut mode is on |
|  | <p>Keyboard lock.</p> <p>Icon is , keyboard locks, long press to unlock.</p> |
|  | <p> means E-load connecting to the PC, it is allowed to Send commands on the PC to perform related operations on the E-load.</p> |

2.5 Rear Panel

The following picture is the rear panel for the HT8XXX E-load.

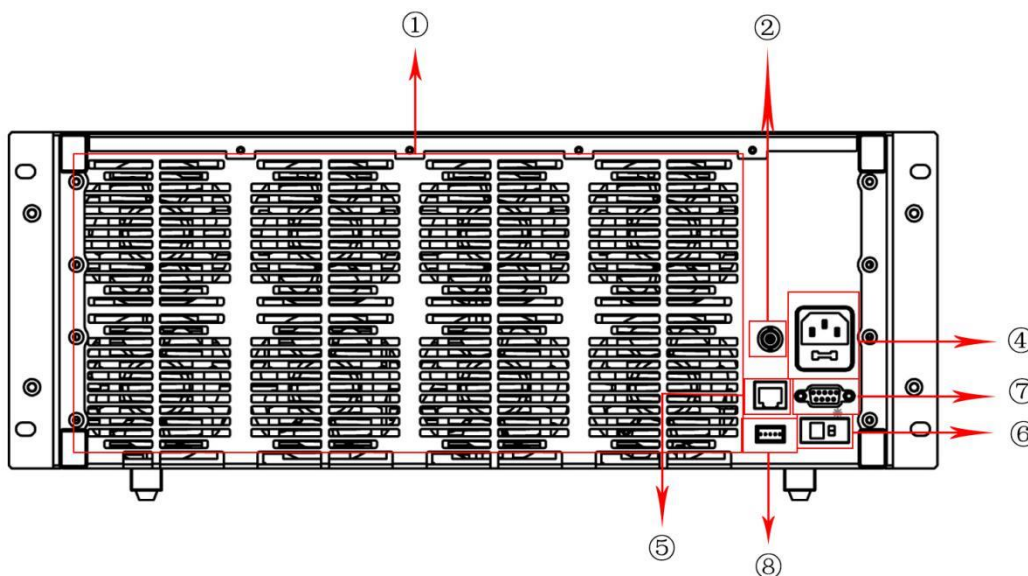



Figure2.3 Rear panel

| Item | Description |
|------|---------------|
| 1 | Cooling holes |

| | |
|---|--|
| 2 | 0 to full-scale current, corresponding to 0-10V output, can be connected to the oscilloscope |
| 3 | |
| 4 | Power inlet (AC 100~240V input) |
| 5 | LAN communication port |
| 6 | SENSE port for voltage sense compensation |
| 7 | DB9 communication interface, RS232/485 |
| 8 | I/O interface connector, this I/O interface need to be powered by external power |

2.6 First turn-on checkout

The successful self-test process indicates that the E-load meets the factory standards and can be used by the user normally. Before operating the E-load, make sure you understand the safety instructions.

| | |
|--|---|
|  CAUTION | <p>Ensure that the line voltage selector switch on the back panel is set to match your line voltage. Failure to do so could result in damage to the instrument.</p> <p>Connect an appropriate power cord to the E-Load and plug the power cord into an AC power outlet. Ensure that nothing is connected to the INPUT terminals.</p> <p>Before operating the E-load, ensure it is well grounded.</p> <p>To prevent damaging the E-load, please pay special attention to positive and negative polarities of E-load during connection!</p> |
|--|---|

2.6.1 Self-test Process

The standard E-load self-test process is as follows:

- 1) Connect an appropriate IEC power cord to the E-load and plug the power cord into an AC power outlet. Press the hardware power button at the back panel. At this time, soft power switch button lights up red in the front panel, long press the soft power switch to power on the instrument.(if the E-load using soft power switch button)
- 2) After the E-load initialization completed, the LCD display shows the working mode

information.

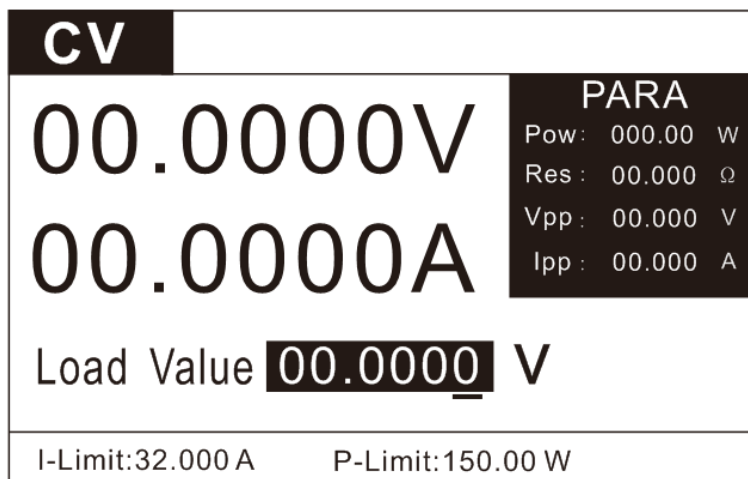

Figure 2.4 CV Work mode Page

2.6.2 In the Event of a Problem

If the E-load fails to power up, the following troubleshooting steps will help you to solve the problem.

1. Make sure the power cord is connected properly and the power switch has been pushed in to ON.

Go to step 2 ---- when the power cord is well connected

Back to step 1----- when the power cord is wrongly connected

2. Check the hardware Power button at the back panel in ON state and the soft Power

Switch  at the front panel is lit red.(if the E-load using soft power switch button)

Go to step 3--- YES

Press the Power button to turn on the instrument and to see if the exception is cleared-----NO.

3. Check whether the voltage of power supply is larger than the rated voltage of the equipment.

Chapter 3 Functions and Features

This chapter will introduce functions and features of HT8XXX E-load in the following sections:

- Basic operation modes
- LIST function
- OCP over current test function
- EFFT load effect test function
- AUTO automatic test function
- DYNA dynamic test function
- BATT battery test function
- SHORT short-circuit simulation function
- LED load simulation function
- SWEEP dynamic frequency conversion scanning function
- TIMEING time measurement function
- Measurement items

3.1 Basic Operation Modes

The E-load has four basic modes:

- 1) Constant current mode (CC)
- 2) Constant voltage mode (CV)
- 3) constant resistance mode (CR)
- 4) Constant power mode (CW)

3.1.1 Constant Current Mode (CC)

In constant current mode, the DC E-load will sink a constant current, regardless of the voltage of the source. See the figure below.

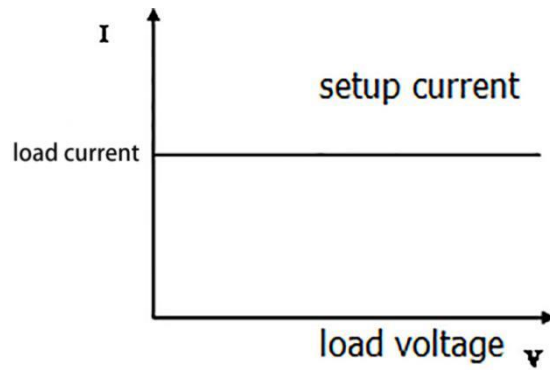

Constant Current Mode

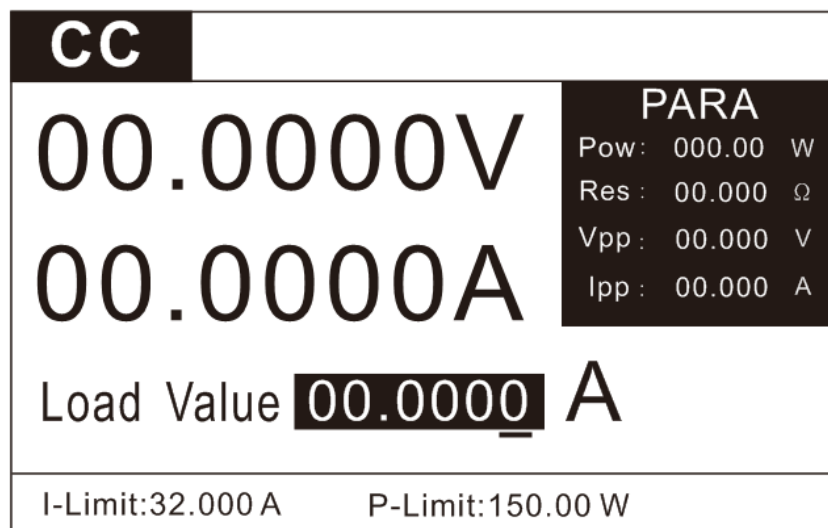





Figure 3.1 CC mode Page

In CC mode, the E-load provides two methods to set the constant current value.

1) In CC mode, use the numeric keys to input the current value, press the key  to

confirm the setup constant current value, and press the key  to load or unload the source.

2) Press the key  to move the cursor position and press the key  to adjust the value at the corresponding position.

3.1.2 Constant Voltage Mode (CV)

In constant voltage mode, the E-load will cause a constant voltage to appear at its terminals.

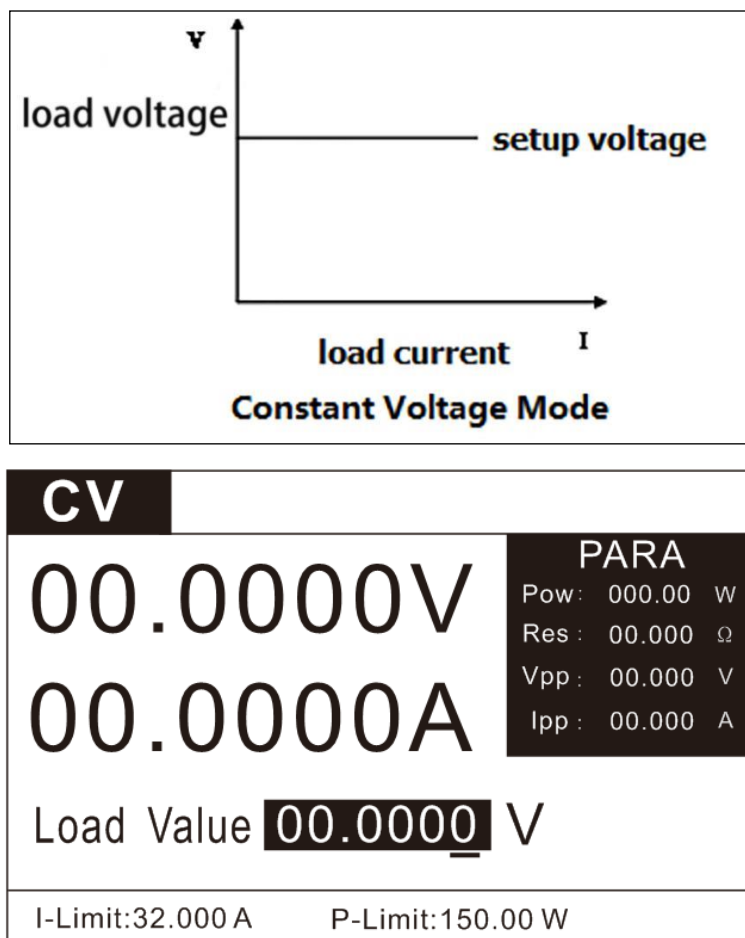





Figure 3.2 CV mode Page

In CV mode, the E-load provides two methods to modify the constant voltage value.

1) In CV mode, use the numeric keys to input the voltage value, press the key  to confirm the setup constant voltage value; press the button  to ON/OFF the loading test.

2) Press the key  to move the cursor position and press the key  to adjust the value at the corresponding position.

3.1.3 Constant Resistance Mode (CR)

In constant resistance mode, the E-load will behave as a fixed resistance value. As shown in the figure below, the E-load changes the current linearly as the input voltage changes.

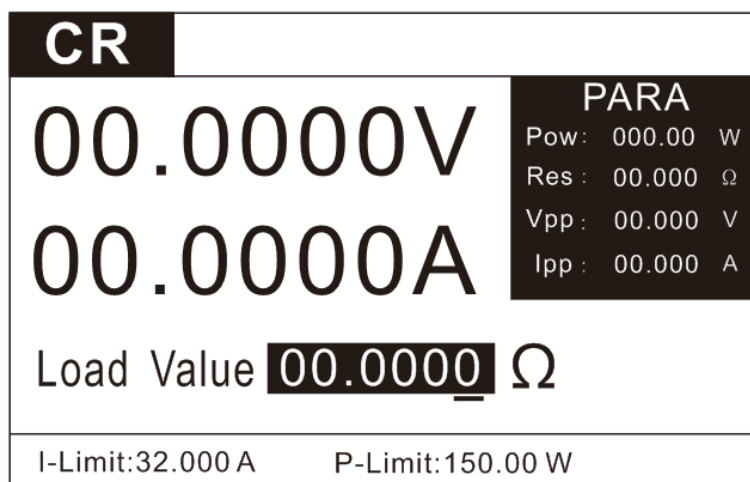
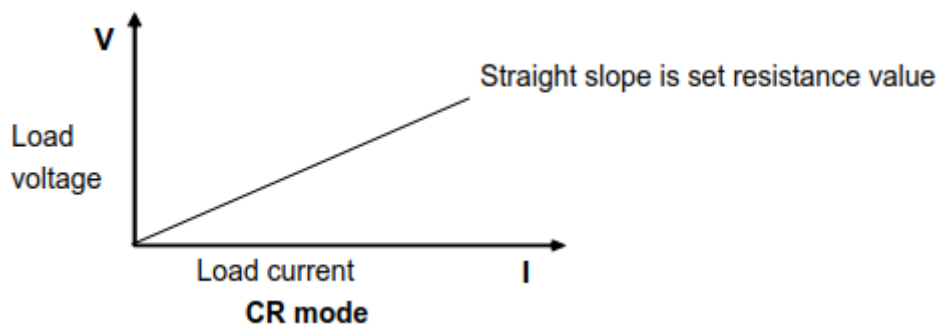





Figure 3.3 CR mode Page

In CR mode, the E-load provides two methods to set the constant resistance value.

1) In CR mode, use the numeric keys to input the resistance value, press the key 

to confirm the setup constant resistance value, and press the key  to on/off the loading test.

2) Press the key  to move the cursor position and press the key  to adjust the value at the corresponding position.

3.1.4 Constant Power Mode (CW)

In CW mode, the E-load will cause a constant power to be dissipated in the load.

As shown in the figure below, if the input voltage rises, the input current will decrease and the power $P(=V * I)$ will remain constant at the level of setup power.

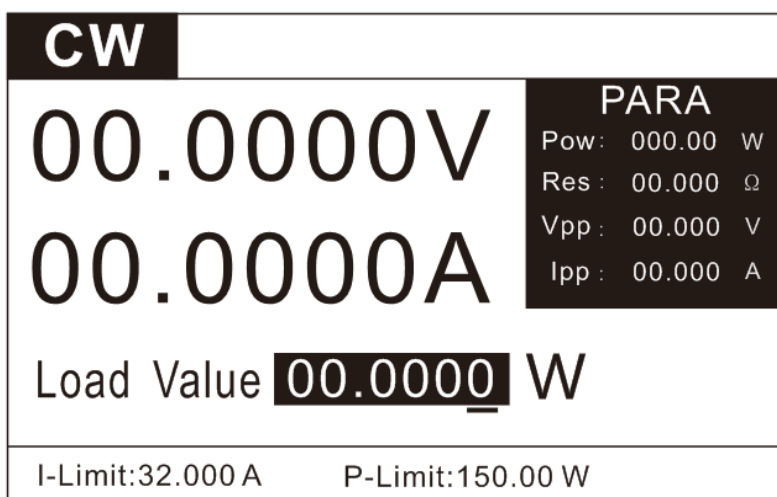
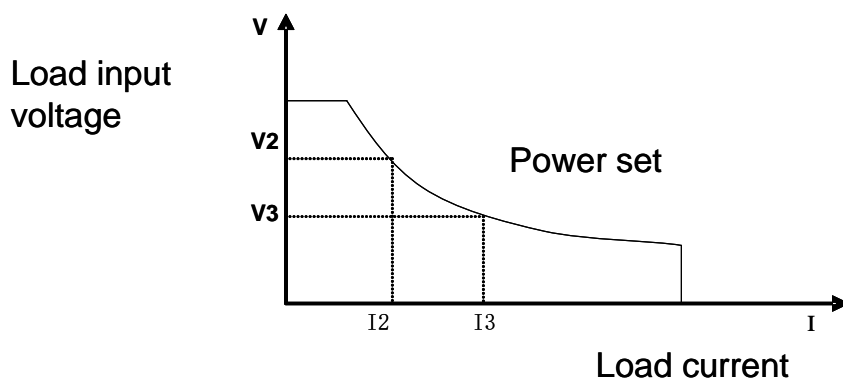





Figure 3.4 CW mode Page

In CW mode, the E-load provides two methods to set the constant power value.

1) In CW mode, use the numeric keys to input the power value, press the key  to

confirm the setup constant power value, and press the key  to on/off the loading test.

2) Press the key  to move the cursor position and press the key  to adjust the value at the corresponding position.

In CW mode, the working loop of the instrument can be modified. (see parameter settings)

3.2 List Operation

With LIST mode, E-load can loading an accurate, fast and complicated current, which can be synchronized by internal or external signals to complete multiple quasi-bit load precision tests.

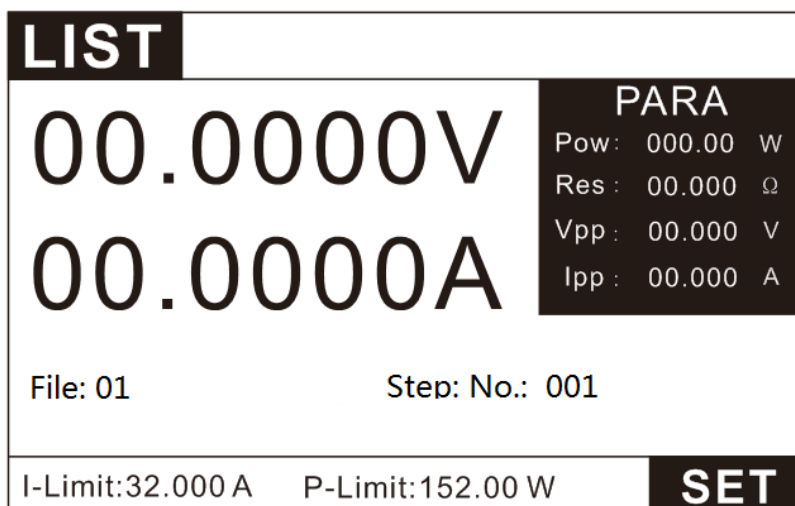

Figure 3.5 LIST mode test Page

Edit the LIST file and trigger to operate this file.

Operation steps:

When different trigger sources are selected, the LIST function will form a variety of complex sequences by editing step value, time and slope of each step to meet complicated test requirements. LIST parameters comprise designation of input list file, input step count (200 steps at maximum), step time (10uS~50S) as well as setting value and slope of each step. The list file can be stored in non-volatile RAM available for a quick output in case of usage. The user can edit 8 groups of list files at maximum.

In list mode ,press the key **SET** to enter the LIST parameter editing interface.

The screenshot shows the LIST file edit page with the following information:

- LIST** (Header)
- File **01** (Left)
- Mode **CONT** (Middle)
- Cont No. **0000000** (Right)
- Table with 4 columns: NO., Curr(A), Time(mS), Rate(A/uS)
- Buttons: **+** (Left), **-** (Right)

| NO. | Curr(A) | Time(mS) | Rate(A/uS) |
|-----|---------|----------|------------|
| 001 | 1.0000 | 1.000 | 3.000 |
| 002 | 2.0000 | 1.000 | 3.000 |
| 003 | 3.0000 | 1.000 | 3.000 |
| 004 | 4.0000 | 1.000 | 3.000 |
| 005 | 5.0000 | 1.000 | 3.000 |

Figure 3.6 LIST file edit Page

| LIST parameter setting | |
|--|---|
| Parameter | Description |
| Curr | Loading current |
| Time | Duration, setting range 10uS ~ 50S |
| Rate | Current slew rate 0.001-3A/uS |
| List mode setting: List test interface→SET | |
| CONT | Continuous mode--sequential loading mode |
| CNT | Counting mode-- when it receives a trigger signal, the load will start List operation for CNT cycles till completion. CNT parameters can be set from 1 ~ 9999999. |
| STEP | Step mode-- when it receives a trigger signal, the E-load will perform the next step according to the next setting parameter in the list file. |
| <p>When setting the parameters:</p> <p>press the key ADD to add one step</p> <p>press the key DELE to delete one step</p> <p>press the key PREV to go up one page</p> <p>press the key NEXT to turn down one page.</p> | |

Users can edit up to 8 sets of list files. If the E-load operation mode is List operation, the E-load will start a List operation when the key ON/OFF is pressed till completion or the ON/OFF is pressed again to stop the loading.

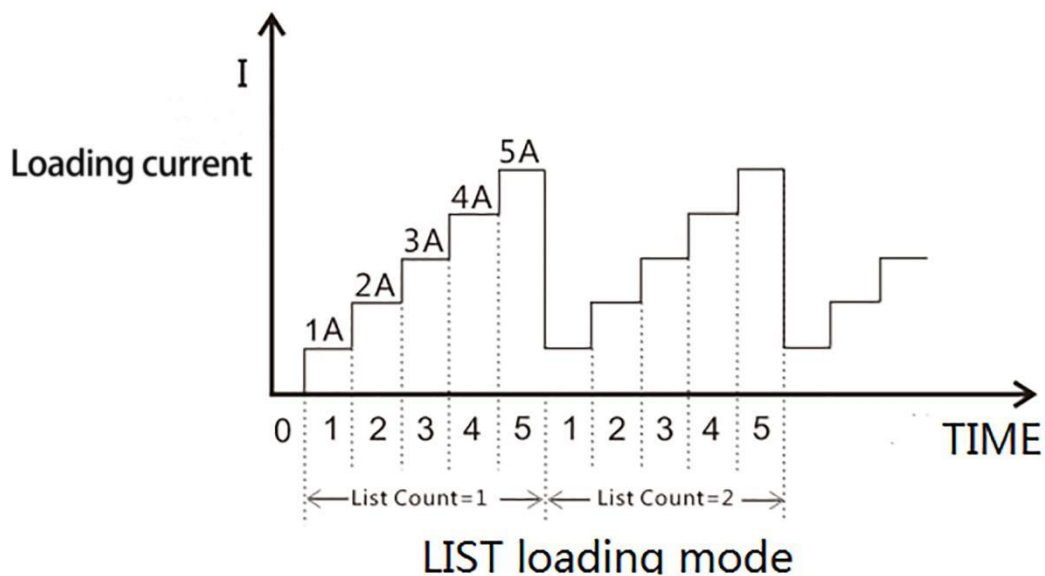

Figure 3.7 LIST loading

For example:

Source under test: constant voltage source 24V, maximum output current 5A

Purposes: to test current output and voltage fluctuation at 5 voltage points of 1A, 2A, 3A, 4A, and 5A.

Operation steps:

1. Press the key **MODE** to enter the mode selection page, press the up and down keys to select LIST, and press the key **ENTER** to enter the LIST test interface.
2. In Figure 3.5, press the key **SET** to enter the setting interface, as shown in Figure 3.6.
3. Select the desired file number by pressing the key +/-, as shown in Figure 3.6
4. Use the up, down, left and right direction keys to select the mode as CONT (the counting function only valid in CNT mode).
5. Set the first step current to 1A, time to 1mS and current rate to 3A/us through the up, down, left and right keys.
6. Press the key ADD to increase the number of steps and set the parameters for each step, as shown in Figure 3.6.
7. After the setting is completed, press the key **ESC** to back to the list test interface, press the key **ON/OFF** to turn on/off the loading. The test waveform is shown in Figure 3.7.

3.3 OCP Test Function

The HT8XXX series E-load is provided with over-current protection test function (OCP). Under OCP test mode, when the voltage of source under test reached V_{on} value, delay for a while for the E-load to latch. Ascend value by step value at regular interval. At the same time, check the E-load input voltage and judge whether it is higher than standard voltage value. If higher, it indicates that OCP does not occur. Repeat current stepping operation till the E-load operates to the cutoff current; If the input voltage is always greater than the OCP trigger voltage, OCP does not occur. When the input voltage is lower than the OCP trigger value, OCP occur and test terminated. After the test, the over-load protection current is judged to be within the set current range.

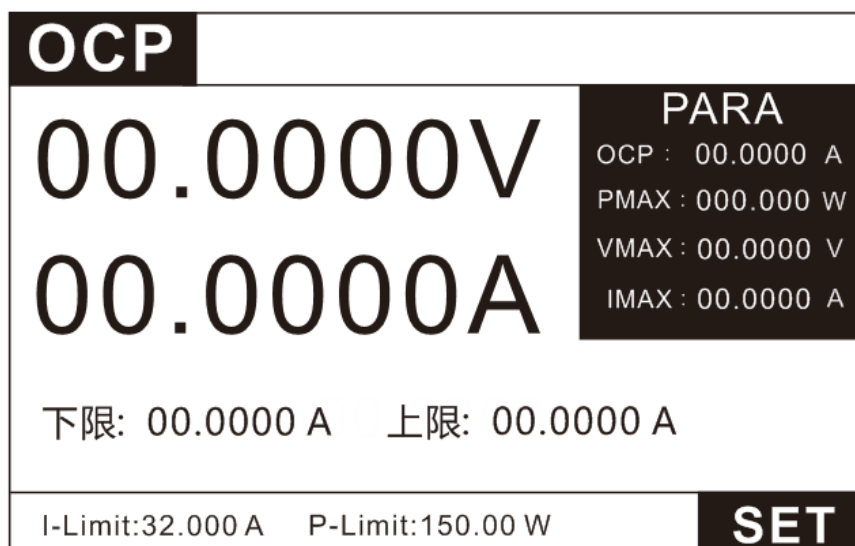

Figure 3.8 OCP test Page

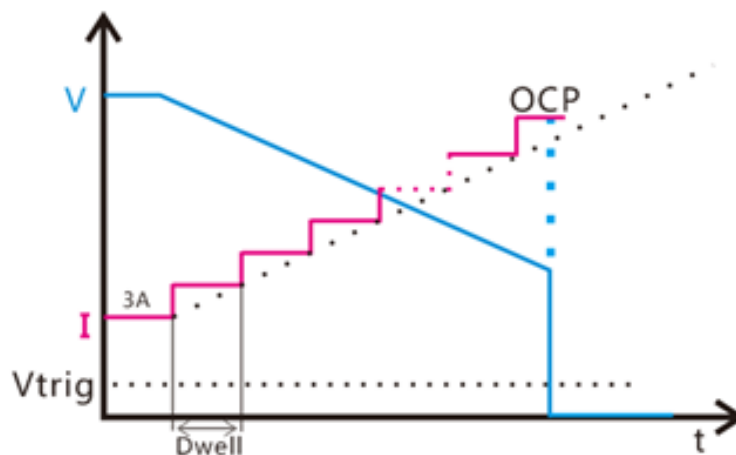

Figure 3.9 OCP loading

| OCP | | | |
|----------|-----------|----------|-----------|
| Istart | 03.0000 A | Iend | 06.000 A |
| Step No. | 00100 | Duration | 0.010 S |
| Limit-H | 05.2000 A | Limit-L | 04.8000 A |
| V trig | 01.0000 V | | |
| | | | |
| | | | |

Figure 3.10 OCP parameter setting Page

OCP parameter

| OCP parameter: | |
|----------------|-----------------------------|
| Istart | Start Current |
| Iend | End Current |
| Steps | Steps (1~1000) |
| Dwell | Step duration (0.01~999.99) |
| V trig | Trigger voltage level |
| Limit-L | Lower limit of over-current |
| Limit-H | Upper limit of over-current |

For example:

Source under test: constant voltage source 24V, maximum output current 5A

Purposes: to judge the current value of over-current protection point between 4.8A and 5.2A or not.

Operation steps:

1. Press the key **MODE** to enter the mode selection page, press the up and down keys to select OCP, and press the key **ENTER** to enter the OCP test interface.
2. In Figure 3.8, press the key **SET** to enter the setting interface, as shown in Figure

3.10. Use the up, down, left and right direction keys to set the parameters as shown in Figure 3.10.

3. The E-load starts loading from 3A and stops at 6A in 100 steps with a step value 0.03A. The delay of each step is 0.01S. When the power supply voltage is less than the 1V trigger voltage, the corresponding current value is the OCP current value, and it is judged whether the OCP current value is within the upper and lower limits of the current. The test waveform is shown in Figure 3.9

3.4 EFFT Function

EFFT test function, its principle shown in the figure below. The load will be carried by three different load-mode Imin\Inormal\Imax. Each loading time continues for a preset time (Delay), then record voltage values in different load-mode. According to the following formula, finally calculated the load-regulation, the maximum differential pressure (ΔV), and the internal resistance (R_s) of the power supply.

$$\Delta V = V_{max} - V_{min}; \quad R_s = \Delta V / (I_{max} - I_{min}); \quad \text{Regulation} = \Delta V / V_{normal};$$

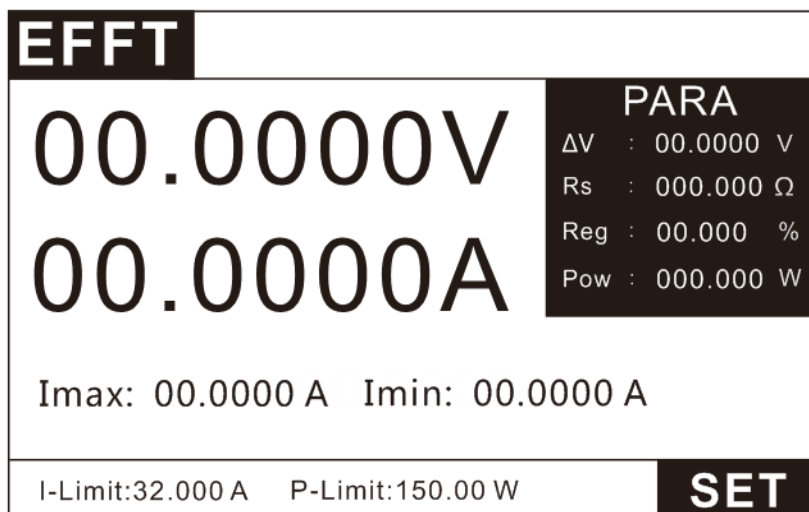



Figure 3.11 EFFT mode test Page

In the EFFT test interface, press to the key  to enter the EFFT parameter editing interface.

| EFFT setting parameter | |
|------------------------|------------------------------|
| Parameter | Description |
| Imin | Draw minimum working current |

| | |
|------------------|------------------------------|
| I _{max} | Draw maximum working current |
| I _{nor} | Draw normal working current |
| Delay | Current duration per step |

For example:

Source under test: constant voltage source 24V, output current 0-5A, normal working current 3A.

Purposes: to calculate regulation= $\Delta V/V_{normal}$

Operation steps:

1. Press the key **MODE** to enter the mode selection page, press the up and down keys to select EFFT, and press the key **ENTER** to enter the EFFT test interface, as shown in Figure 3.11.
2. In Figure 3.11, press the key **SET** to enter the setting interface
3. Set minimum current at 0A, maximum current at 5A, normal current at 3A, delay value at 0.5S.
4. The E-load will carry the three setup currents separately, record the corresponding voltage value, and calculate ΔV , R_s , Reg. Observe whether the Reg test value meets the design requirements

3.5 Auto test function

Auto test function is used for product inspection of the production line. The load current is loaded and tested sequentially according to the steps edited in the file to automatic judge the product qualified or not.

The E-load supports up to 8 files, each file supports up to 50 steps. Each load condition of the step can be set, detection type (SPEC) and delay time (Delay). The delay time can be set to wait for the trigger signal (when the time is greater than 99.99S), or it can be any time ranging from 0.1S to 99.99S. The load condition supports a variety of working modes (Mode), and the detection types (SPEC) supported by different working modes are also different. See the following table for details. The load parameters in each mode are also different. See the corresponding chapters of each mode. Introduction.

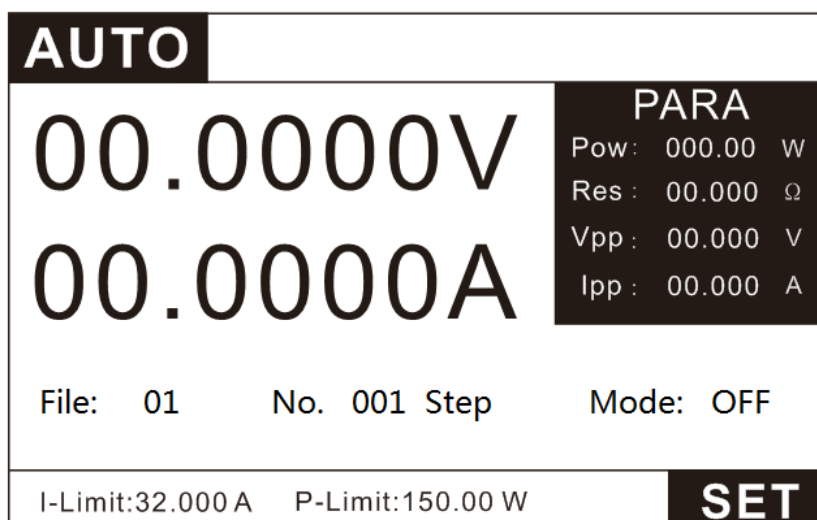

Figure 3.12 AUTO test Page

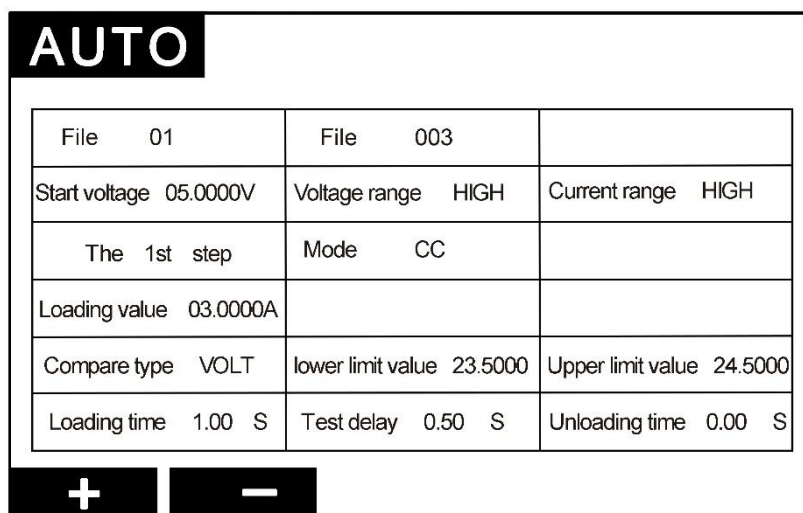

Figure3.13 AUTO test editing Page

Auto test file list

| AUTO setting parameters | |
|-------------------------|---|
| File | 1-8 file available |
| Step number | Each file allows 0 to 50 steps |
| Start voltage | A trigger voltage value start to automatically load |
| Voltage range | Choose the appropriate voltage range according to the real test condition |
| Current range | Choose the appropriate current range according to the real test condition |
| The Nth step | Select the specified step for parameter setting |

| Mode | Description |
|---|--|
| OFF | Empty |
| CC | CC mode |
| CV | CV mode |
| CW | CW mode |
| CR | CR mode |
| SHORT | Short |
| OCP | OCP |
| Effect | EFFECT |
| LED | LED driver source test mode |
| Comparison type setting: AUTO parameter editing interface → comparison type | |
| Curr | Load current, valid in CC/CV/ CP/CR/LED mode |
| Volt | Input voltage, valid in CC/CV/ CP/CR/LED mode |
| Pow | Load power, valid in CC/ CV/CP/CR/LED mode |
| Res | Equivalent resistance, valid in CC/ CV/CP/CR/LED mode |
| Vpp | Ripple voltage, valid in CC/CV/CP/CR/LED/DYNA mode |
| Ipp | Ripple current, valid in CC/ CV/ CP/ CR/LED/DYNA mode |
| OCP | Over-current protection point, valid in OCP mode |
| Pmax | Maximum output power point, valid in OCP mode |
| Reg. | Load regulation, valid in Load Effect mode |
| ΔV | Voltage difference between the two loads, valid in Load Effect mode. |
| Rs | Power supply series internal resistance, valid in Load Effect mode |
| Time setting | Different modes have different test time settings |
| Duration/time setting | Load time |
| Test delay | Time from start loading to read the test value |
| Unloading time | wait time for completing a single step test (Figure 3.14) |

| | |
|--|--|
| Trigger output and test process setting: test page → press MENU → system setting → press Enter → press the up and down keys to select the output item | |
| Output mode | |
| Level | Level trigger (low level valid) |
| Pulse | Pulse trigger (Pass 5mS,fail 10mS) |
| Output conditions | |
| Pass | Start trigger output (TRO) when the test passed |
| Fail | Start trigger output (TRO) when the test failed |
| End | Start trigger output (TRO) when the test ended |
| Disable | Disable trigger output |
| Fail action | |
| Cont | Continue to complete all measurements when the single step detection item is judged to be unqualified. |
| Abort | The auto test is terminated immediately when the single step item is judged to be unqualified. |

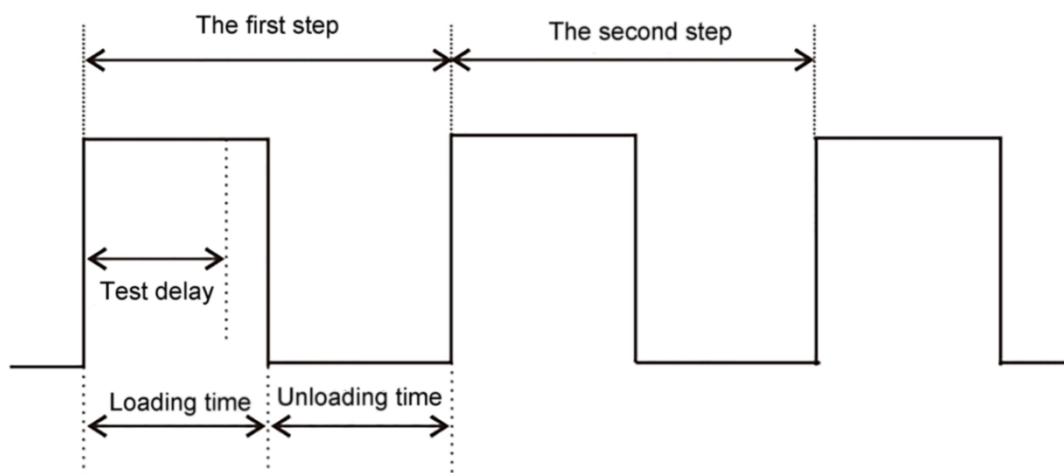

Figure 3.14 Test time

For example:

Object under test: constant voltage source 24V, output current 0-5A, normal working current 3A.

Purposes: to test comprehensive performance of power supply

1. Load capacity test: 3A normal current, to compare voltage within range of 23.5~24.5V.

2. Over-current protection test: use OCP mode to test if the power supply over-current point within the range of 4.8~5.2A.
3. Load effect test: use EFFT mode to test if the load effect of the power supply is within 0.5%.
4. Judgment qualified: output level signal when the test fails.

Operation steps:

1. Press the key **MODE** to enter the mode selection page, press the up and down keys to select AUTO, and press the key **ENTER** to enter the AUTO test interface, as shown in Figure 3.12.
2. In Figure 3.12, press the key **SET** to enter the setting interface, as shown in Figure 3.13.
3. Select the file 1 by pressing the key + /-, set the steps to 3.
4. Set auto trigger level to 5V. After using ON/OFF to start test for the first time, in the future, when load detects an input voltage greater than 5V, the load will automatically turn on the ON/OFF function.
5. Select step N, using numeric keys to set steps, and set the 1st step first.
6. Mode setting, select CC mode, and set the load value at 3A.
7. Compare type and voltage, to set upper limit to 24.5V and lower limit to 23.5V.
8. Set the load time to 1S, test delay to 0.5S, and unloading time to 0S, that is, no unloading delay required, and directly start loading the next step.
9. Select step N, using numeric keys to set steps, and set the 2nd step.
10. Mode setting, select OCP mode, set start current to 3A and end current to 6A; Select compare type at OCP, set upper limit value to 5.2, lower limit value to 4.8, step time to 0.1S, trigger level to 1V, refer to Chapter 3.3 for details.
11. Set the unloading time. The power supply stops output after over-current occurred. We here set the unloading time to 1S (different power supplies have different protection recovery time, it is allowed to set unloading time), start to the next step until the power supply restore to output.
12. Select step N, using numeric keys to input 3 to set the 3rd step.
13. Mode setting, select EFFT mode, set min current to 0A and max current to 5A, normal current to 3A; Select compare type at Reg., set upper limit value to 1, lower limit value to 0(0~1%), Set test time to 1S, delay to 0.5S, and unload delay to 0 (that is, each current load time is 1S, and test and compare the data after 0.5S at each step), refer to Chapter 3.4 for details.
14. press the key **ESC** to return the test interface after set the 3 test steps.
15. Output level signal when test result is unqualified. Test interface → press **MENU** key → system setting → press **ENTER** key → press the up and down keys to select the output item. Refer to Chapter 4.2 for how to set the parameters in details.
16. Set the output mode to level, output condition to unqualified, and failed action to stop. This means, when the test result is unqualified, the TRO port outputs a low level signal. Stop testing the next steps when one step fails.
17. After the above settings are completed, press **ESC** return test interface. Press **ON/OFF** to start the test. Because start voltage is set to 5V, in the future, when the E-load detects an

input voltage greater than 5V, the E-load will automatically start to test. (If start voltage set at 0V means to turn off this function)

18. After the test is completed, by the left and right buttons to go to test data interface. Observe unqualified items and detailed test data.

3.6 Dynamic Function

The dynamic mode make the E-load to switch repeatedly between the two load currents. This function is usually used to test dynamic characteristics of the source. The principle is shown in the figure below. The E-load loaded the source with the current I_b for T_b time interval and then according to the setting flow rate. The load-current drops to the I_a load in setting flow rate, and the entire drop time and the I_b load duration are T_b . Then, the load current rise in setting up-rate from I_a to the I_b load-current. So the E-load switch repeatedly in this manner to detect the dynamic characteristics of the source. The varying load causes the source to overshoot and fall, and the E-load will display the overvoltage voltage peak V_{p+} and the falling voltage valley V_{p-} in real time.

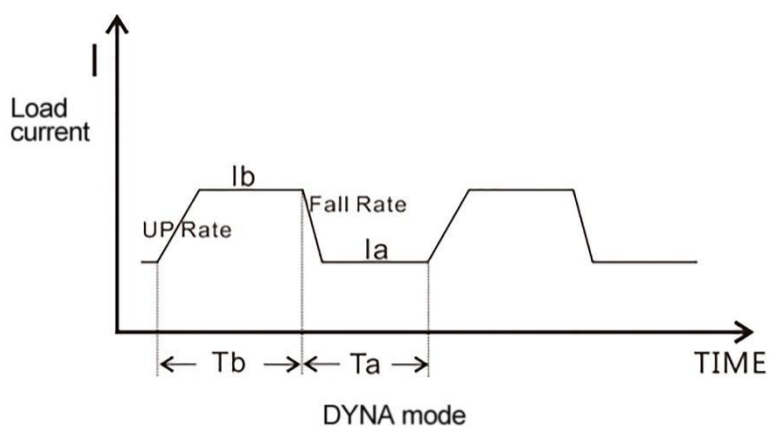

Figure 3.15 DYN loading

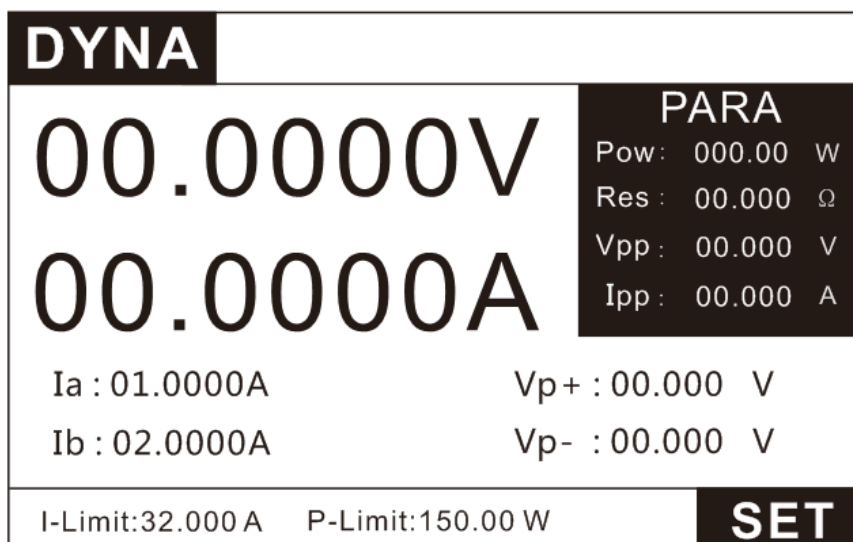

Figure 3.16 DYNA testing Page

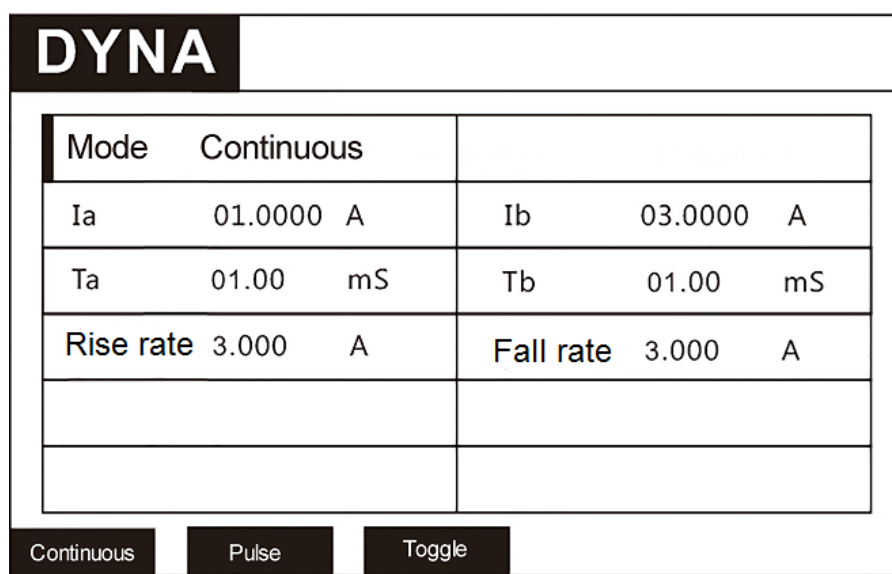



Figure 3.17 DYNA Setting Page

| DYNA mode setting | |
|-------------------|--|
| Continuous | In continuous mode, the E-load can load between high and low current in different rise rates and duration. |
| Pulse | In pulse-mode, with dynamic test operation enabled, the load will switch to Ib every time after receipt of a trigger signal and switch back to Ia value after maintaining Tb for pulse width time. |

| | |
|--------|--|
| Toggle | In toggle mode, the load current will drop to I_a according to the set current rate, or rise to I_b according to the set current rate after receipt of every trigger signal. |
|--------|--|

| DYNA setting parameters | |
|---|---|
| Parameter | Description |
| I_a | Low level loading current |
| T_a | Low level current duration, setting range 10uS~50S |
| I_b | High level loading current |
| T_b | High level current duration, setting range 10uS~50S |
|  | Current rise time rate A/uS |
|  | Current fall time rate A/uS |
| Mode | Continuous/ Pulse/ Toggle |

Continuous mode

In continuous mode and dynamic function enabled, the E-load continuously switch between two load values

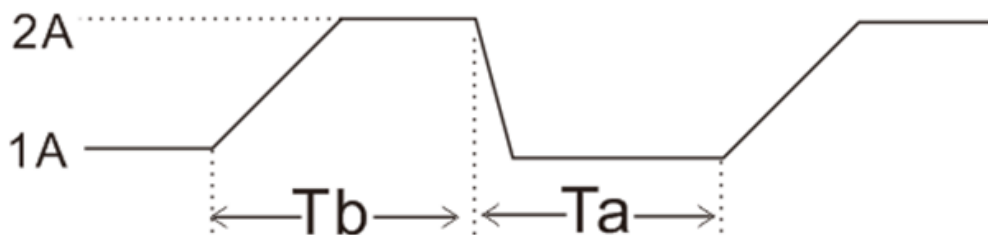

Figure 3.18 DYNA- Continuous mode

Pulse mode

In pulse mode, after enabling dynamic test operation, the E-load will switch to I_b value every time after receipt of a trigger signal and switch back to I_a value after maintaining T_b for pulse width time.

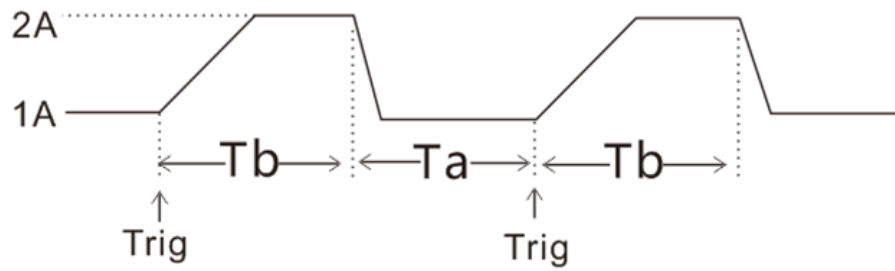

Figure 3.19 DYNA- pulse mode

TRIGGER mode

In toggle mode, after enabling dynamic test operation, the load will be switched continuously between I_a value and I_b value after receipt of every trigger signal.



Figure 3.20 DYNA- trigger mode

Trigger control

When the dynamic test mode is set to pulse mode, or trigger mode, the trigger control is activated. The trigger mode has 3 types:

1) Button trigger:

Trigger once when the TR button is pressed once;

2) External hardware input trigger:

Trigger when TRI terminal level in the rear panel of the E-load is continuously at a low level of 5mS or more.

3) The host computer software controls the trigger.

For example:

Object under test: constant voltage source 24V, output current 0-5A, normal working current 3A.

Purposes: to test power supply dynamics characteristic, V_{p+} , V_{p-}

Operation steps:

1. Press the key **MODE** to enter the mode selection page, press the up and down keys to select DYNA, and press the key **ENTER** to enter the DYNA test interface, as shown in Figure 3.16.
2. In Figure 3.16, press the key **SET** to enter the setting interface, as shown in Figure 3.17.
3. As shown in Figure 3.17, set the test mode to continuous test, high current $I_b=3A$, high time $T_b=1mS$, low current $I_a=1A$, low time $T_a=1mS$, rise/fall rate= $3A/uS$.
4. After the above settings are completed, press **ESC** to return the test interface, and press **ON/OFF** to start the test.
5. Observe the values of V_{p+} and V_{p-} during the test.

3.7 Battery test function

The CC, CP and CR mode can be applied for battery-capacity test with discharge conditions. Discharging time and discharged capacity (AH or WH) of the battery can be always observed during the test. When the battery discharge meets the setting termination conditions, the E-load will completes the test and stop loading.

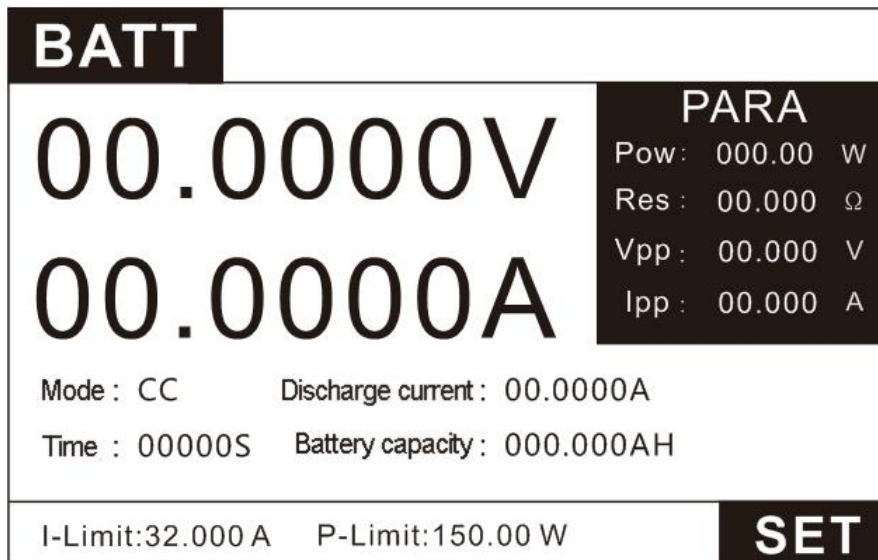



Figure 3.21 Battery mode test Page



| BATT | | | |
|------------|-----------|-----------------|------------|
| Mode | CC | Discharge curr. | 01.0000 A |
| Stop time | 0000 S | Unit | AH |
| Stop volt. | 03.0000 V | Stop cap. | 02.4000 AH |
| | | | |
| | | | |
| | | | |

CC CW CR

Figure 3.22 Battery mode setting page

| BATT Setting parameters | |
|-------------------------|--|
| Parameters | Description |
| Mode | Discharge mode CC/CW/CR |
| Value | Load value in different discharge modes |
| Stop Time | Discharge stop time (termination conditions) |
| Unit | AH/WH |
| Stop Volt | Discharge stop voltage (termination conditions) |
| Stop Cap | Discharge stop capacity (termination conditions) |





After the above setting confirmed, press the key  to start testing. When the set stop conditions is reached, the test will be stopped and the load input status turn to be OFF.

Press the key  to stop testing, the  light will be OFF and the load input status turns to be OFF, the battery stops discharging.

Source under test: 18650 battery rated voltage 3.7V, capacity 2400mAh.

Purpose: check the battery with a capacity of 2400 mAh when it discharging from full-charge to the lowest voltage

Operation steps:

1. Press the key  to enter the mode selection page, press the up and down keys to select BATT, and press the key  to enter the BATT test interface, as shown in Figure 3.21.
2. In Figure 3.21, press the key  to enter the setting interface, as shown in Figure 3.22.
3. As shown in Figure 3.22, set the discharge mode to CC mode, current at 1A, stop time at 0S (when the stop condition is set to 0, it does not participate in the stop judgment.), the stop voltage at 3V, and the stop capacity at 2.4Ah.
4. After the setting is completed, press the key  to back to the test interface, press the key  to start testing.
5. In the above conditional test, when the battery voltage is lower than 3V, or the capacity is accumulated to 2.4Ah, the test will stop immediately.

3.8 Short-circuit Simulation Function

The E-load can simulate a short circuit to the source under test. This function is used to check whether the protection function of the source operated normally under the short-circuited condition.

Under board operation, press the  key to switch short circuit status. Actual current value consumed by E-load at short circuit depends on the existing current range of the E-load. The maximum short-circuit current is 110% of current range.

The short circuit test interface is as follows:

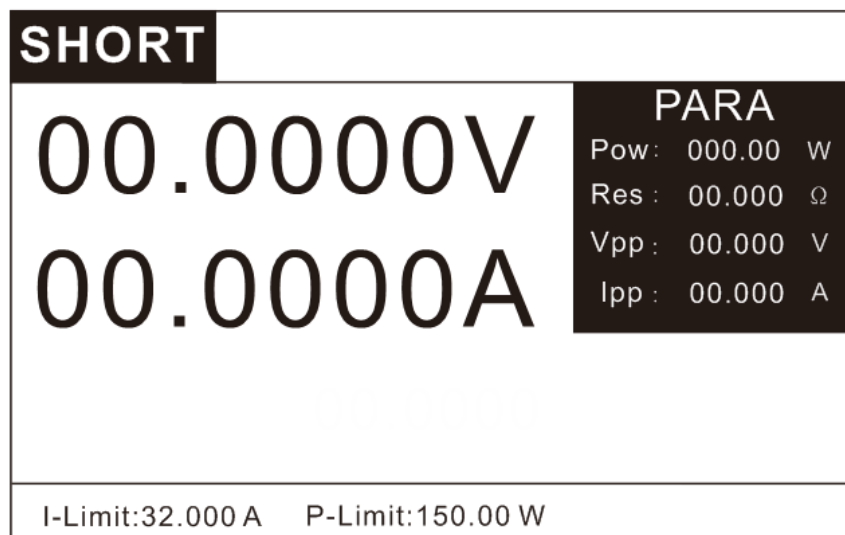

Figure 3.23 Short-circuit mode test Page

3.9 LED Simulation Function

The E-load can simulate the LED at the input, press the key **MODE** on the E-load front panel to select the LED function to switch the LED working state. The LED equivalent circuit is as follows:

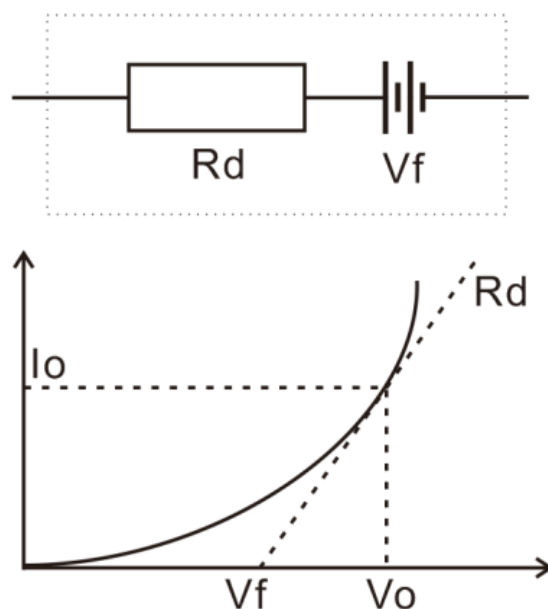

Figure 3.24 LED I-V curve

I_o ---- rated working current, which should be set as the rated current of measured LED driver.

V_o ---- rated working voltage, which can be set as any value of output voltage range of the

measured LED driver

Rd --- Resistance of LED driver, can be calculated by V-I curve

$$Rd \text{ Coefficient} = Rd / (Vo / Io)$$

Vf—LED Positive conduction bias, can be calculated from the Rd, please find the specific example as follows.

Rf ——resistivity of the working point, can be calculated from the Rd

LED is equivalent to the resistor Rd and the power source Vf in series. Its I-V curve is equivalent to the tangent of the true LED nonlinear VI curve at the operating point (Vo, Io),as shown in Figure 3.24:

$$Vo = Vf + Io \times Rd; \text{----- formula 3.1}$$

$$\text{Let } Vf = a \times Vo; \quad (a < 1)$$

$$Vo = a \times Vo + Io \times Rd;$$

$$Rd = (1 - a) \times \frac{Vo}{Io}$$

Let coeff = Rf = 1-a

$$\text{That is } Rd = Rf \times \frac{Vo}{Io}$$

$$a = 1 - Rd \times \frac{Io}{Vo}; \text{----- formula 3.2}$$

By checking LED specification to know Vo, Io, and Rd, a can be calculated by formula 3.2;

$$Rf = 1 - a = Rd \times \frac{Io}{Vo}; \text{----- formula 3.3}$$

| LED | | |
|--------|-----------|------------------|
| Led Vo | 000.000 V | Led Io 00.0000 A |
| Led Rf | 0.000 | |
| | | |
| | | |
| | | |

Figure 3.25 LED Mode setting Page

| LED setting parameters | |
|------------------------|----------------------------|
| Parameters | Description |
| Led Vo | Voltage of operating point |
| Led Io | Current of operating point |
| Led Rf | Coefficient Coeff |

Io is given by LED Driver, if there is an error between the actual output and the set value, the corresponding load value Vo will be different. For example, if Io is set to 1A and the actual output current of the power supply is 1.1A, the actual output voltage value will also be higher. It is normal for a slight deviation to the output voltage. The specific formula is as follows:

The actual load-value is loaded according to the following formula:

$$V_x = (1 - \text{Coeff}) \times V_o + I_x \times \text{Coeff} \times \frac{V_o}{I_o};$$

Vx: The output voltage of the LED driver under actual load adjustment.

Ix: The output current of the LED driver under actual load adjustment.

Set different Vo, Io and Rf, the calculation above will bring different data.

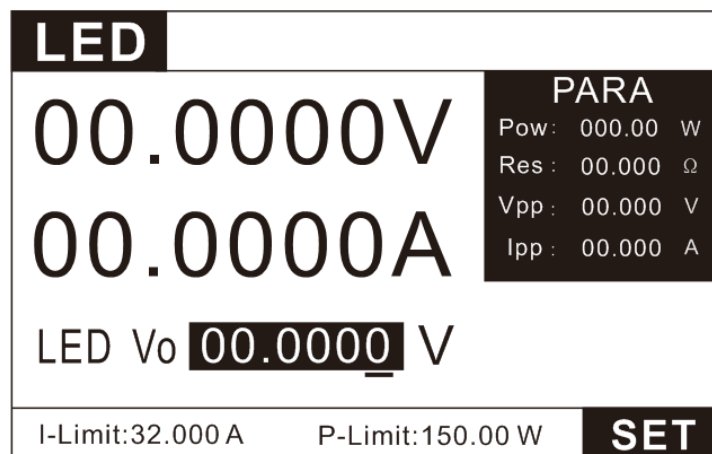

Figure 3.26 LED mode testing page

Parameter calculation:

The users need to set Vo, Io, Rf in LED mode.

Vo, Io can be obtained from the parameters described the LED characteristic. The real load is usually a LED string (n pieces LED in series). Vo should be set to n times the single-section parameter. It can also be set to any value in the LED driver output voltage

range. Regardless of the number of LED in series, the operating point resistance R_d is equal to Coeff ($\text{Coeff} < 1$) multiplied by the value of V_o/I_o .

Therefore, the user can get I_o from the rated output current of LED driver and calculate the $R_d\text{Coeff}$ parameter according to I-V curve on LED specification. It is allowed for users to perform any real LED simulation loading on the LED driver by arbitrarily adjusting within the output voltage range of LED driver.

Example:

LED Driver has a output current I_o of 350mA and output voltage range of 20~50V

A LED light bar has 10 piece LEDs in series, each single LED I-V curve showed in Figure 3.27.

The working voltage V_o of a single LED at 350mA is 3.44V, the sum working voltage is 34.4V when 10 piece LED in series.

Purpose: test LED driver specification

Operation steps:

1. Press the key **MODE** to enter the mode selection page, press the up and down keys to select LED, and press the key **ENTER** to enter the LED test interface, as shown in Figure 3.26.
2. In Figure 3.26, press the key **SET** to enter the setting interface, as shown in Figure 3.25, set $V_o=34.4\text{V}$, $I_o=0.35\text{A}$, $R_f=0.173$. Then R_f is calculated as follows:
3. According to the V-I curve in Figure 3.27, the tangent line slope of the working point is the operating point resistance R_d ,

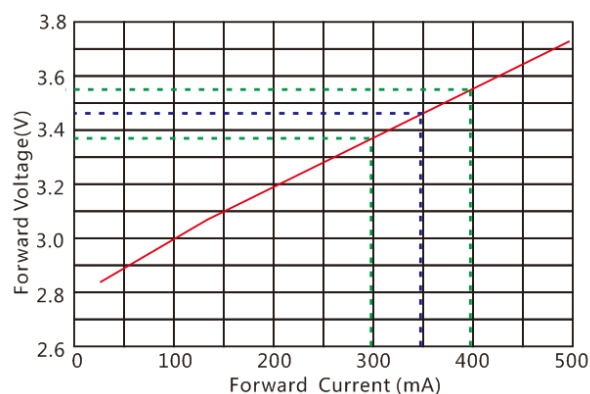



Figure 3.27 LED lamp V-I curve

so a single LED $R_d = R_d = \frac{3.52-3.35}{0.4-0.3} = 1.7 \Omega$

From formula 3.3, $R_f = R_d \times \frac{I_o}{V_o} = 1.7 \times \frac{0.35}{3.44} = 0.173$

4. After the setting is completed, press the key  to back to the test interface, press the key  to start testing.

3.10 SWEEP dynamic frequency conversion scanning

The E-load provides a variable frequency sweep function to capture the V_{p+} and V_{p-} of the power supply under test in the most severe conditions. Be similar to the DYNA mode, the E-load switch repeatedly between the two loads according to the preset current rise rate and current drop rate, and the difference is that the duration of each current level will be determined by the sweep frequency and duty cycle (Duty). At the same time, the scanning frequency will also gradually increase from the starting scanning frequency (F_{start}) to the cutting frequency (F_{end}), the step frequency is (F_{step}), and the scanning duration of each frequency point is single frequency time (Dwell), during the scanning process, the input voltage will overshoot and fall accompanied by the transient of the current. The E-load will display the voltage peak (V_{p+}) during overshoot and the voltage valley (V_{p-}) at the time of the fall, and finally show the maximum of V_{p+} , the minimum of V_{p-} , and the frequency point at which each occurs.

Press the key  on the front panel of the E-load and select the SWEEP function to switch the test mode.

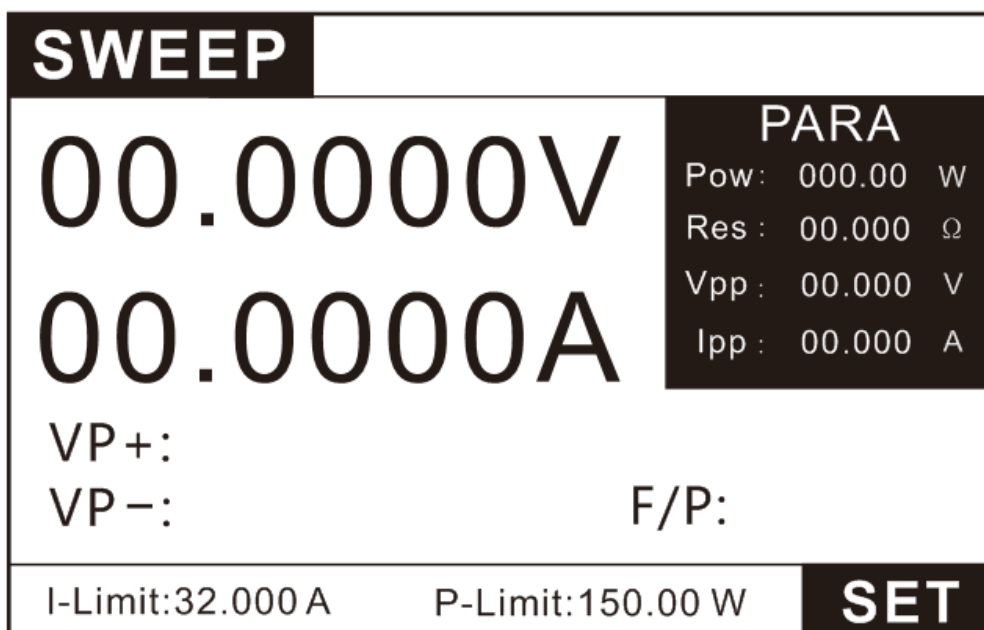



Figure 3.28 SWEEP function testing page

| SWEEP | |
|-----------------------------|-----------------------------------|
| Low current 01.0000A | Low level load current 0.100 S |
| High current 03.0000 A | High level load current 50 % |
| Starting frequency 50.0Hz | Initial scan frequency 3.000 A/us |
| Cut-off frequency 1000.0 HZ | Cut-off scan frequency 3.000 A/us |
| Step frequency 10.00HZ | Step frequency AUTO |
| | |

Figure 3.29 SWEEP function setting Page





| SWEEP setting parameters | |
|-----------------------------|--------------------------------------|
| Parameter | Description |
| Low current (Imin) | Low level load current |
| High current (Imax) | High level load current |
| Starting frequency (Fstart) | Initial scan frequency, 0.01Hz~50KHz |
| Cut-off frequency (Fend) | Cut-off scan frequency, 0.01Hz~50KHz |
| Step frequency (Fstep) | Step frequency, 0.01Hz~50KHz |

| | |
|---|--|
| Single frequency time (Dwell) | Single frequency point duration,0.001S~99.999S |
| Duty cycle (Duty) | Duty cycle,1%~99% |
| Rising rate  | Current rise rate 0~3 |
| Rate of decline  | Current drop rate 0~3 |
| Operating mode (mode) | Auto: auto-execute by setting Manual: Press the up and down keys to adjust the frequency, step frequency is Fstep |

Test case: constant voltage source is 24V, output current is 0-5A, normal working current is 3A.

Test purpose: Power Dynamics, V_p+ , V_p- .

Setup steps:

1. Press the key  to enter the mode selection page, press the up and down keys to select SWEEP, and press the key  to enter the SWEEP test interface shown in Figure 3.28.
2. As shown in Figure 3.28, in the SWEEP interface, press the key  to enter the setting interface shown in Figure 3.29.
3. Set the E-load according to the parameters shown in Figure 3.29. The load will be carried for 0.1S from the frequency of 50Hz when high level is 3A and low level is 1A, and then switch to 60Hz for 0.1S stepping of 10Hz. In this way, the load will stop to be carried until the frequency reaches 1000Hz.
4. After the setting is completed, press  to exit to the test interface, press the key  to start/stop the test.

3.11 TIMING Time measurement

The E-load provides time measurement function with an accuracy of 0.1mS. Under the predetermined load condition, the E-load automatically captures 2 trigger signals and calculates the time interval. After the test is completed, the E-load shows the time interval (Time) of the two triggers. Press the key  on the front panel of the E-load and select the TIMING function to switch the test mode.

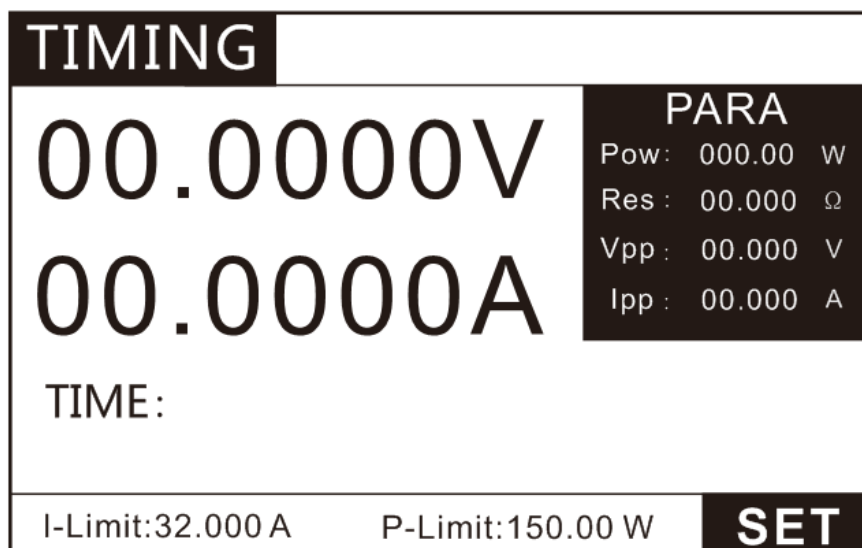

Figure 3.30 TIMING mode testing Page

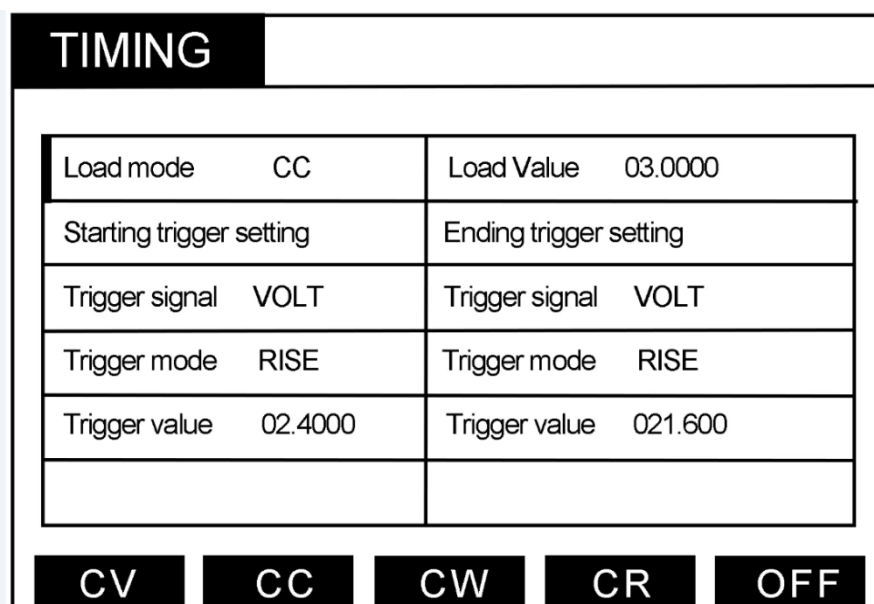

Figure 3.31 TIMING mode setting interface

TIMING function parameter table:

| TIMING parameter settings | |
|---------------------------|--|
| Parameter | Description |
| Load mode (Load mode) | CC/CV/CP/CR/OFF available |
| Load Value (Load Val) | Set the load value of current, voltage, etc. |

| Starting trigger setting (TRIG.START) | |
|---------------------------------------|--|
| Trigger signal (Signal) | VOLT/CURR/EXT(External trigger) |
| Trigger mode (Edge) | rise (RISE) /fall (FALL) |
| Trigger value (level) | When the voltage, current, etc. trigger setting value is started, the timing starts. |
| Ending trigger setting (TRIG.END) | |
| Trigger signal (Signal) | VOLT/CURR/EXT(External trigger) |
| Trigger mode (Edge) | rise (RISE) /fall (FALL) |
| Trigger value (level) | When the voltage, current, etc. trigger setting value is started, the timing starts. |

For example: constant voltage source is 24V, output current is 0-5A, normal working current is 3A. Test purpose: Power climb time, the time of the power climbing from 2.4V to 21.6V.

Setup steps:

1. Press the key **MODE** to enter the mode selection page, press the up and down keys to select TIMING, and press the key **ENTER** to enter the TIMING test interface diagram shown in Figure 3.30.
2. As shown in Figure 3.30, in the TIMING interface, press the key **SET** to enter the setting interface shown in Figure 3.31.
3. Set the load parameters according to the values shown in Figure 3.31. the waiting time is from the load detection to the rising edge of 2.4V to the load detection to the rising edge of 21.6V, is equal to the climb time of the power supply. The minimum detection time is 100uS.
4. After the setting is completed, press **ESC** to exit to the test interface, press the key **ON/OFF** to start/stop the test.

3.12 Measurement item

The E-Load's measurement items include: load-voltage, load-current, load-resistance, load-power, ripple-voltage V_{pp} , and ripple-current I_{pp} .

3.12.1 Voltage, current, resistance and power measurement

The E-load display the average voltage value and the average current value in real time at measurement page. The maximum measurement bandwidth is 250kHz, and accurate measurement can also be realized under large ripple conditions. The E-load provides two measurement rates, fast and slow. In the harsh conditions, we recommend that you use slow rate, which can achieve better stable reading. Voltage and current are set with two ranges (see

Chapter 4.1 System Settings for specific gear settings). Using small rang can achieve more accuracy if necessary.

The value of load-resistance and load-power corresponding to load-voltage and load-current can be read directly in the PARA column.

3.12.2 Ripple measurement

The E-load can test voltage ripple (V_{pp}), current ripple (I_{pp}) and display in real-time. The measurement method is different from the traditional measurement of oscilloscope with blocking capacitance. The E-load ripple measurement within the measurement bandwidth behave a good flat, so the ripple measurement is more accurate and has extremely high repeatability. However, the traditional measurement method will cause the switch ripple to be attenuated due to the capacity of electrolytic capacitor, and the cable. The difference of capacity result in varying degrees of attenuation, has both large errors and poor repeatability. In general, the ripple contains two different frequency bands of the power frequency ripple and the switching ripple, and the ripple of the load is measured as the combined amount of the two ripples.

Chapter 4 System settings and Save function

Press key **MENU** to go to system configuration and save f interface, as shown below:

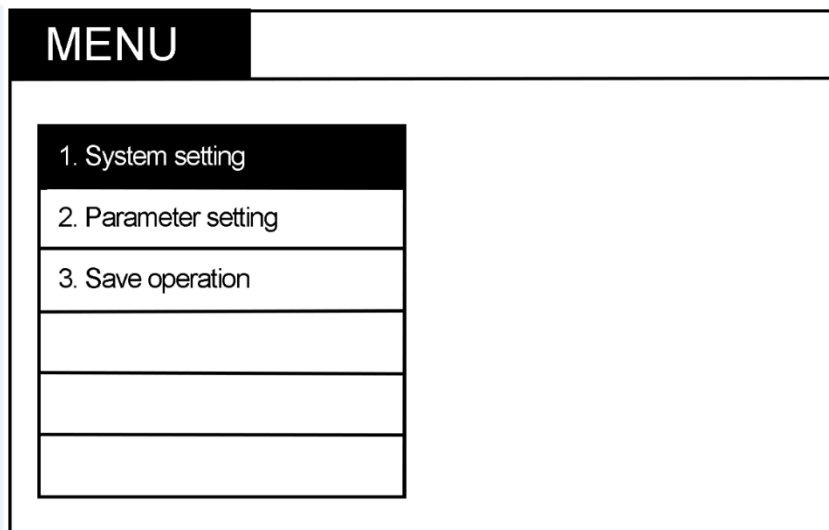

Figure 4.1 MENU Page

The system settings is used to set the parameters of the load, such as range, protection, Von, Voff, etc.

The parameter settings mainly contain common parameters setting of the load, communication and output interface signals.

The save function mainly stores and recalls the common setting for convenient and fast usage.

4.1 System Settings

In MENU page, select the item SYSTEM and press the key **ENTER** to enter the parameter setting page, as shown below.

| SYSTEM | | | |
|-----------|------------|--------------|------------|
| V-Range | HIGH | I-Range | HIGH |
| I-Prot | 032.000 A | P-Prot | 155 W |
| V on | 00.0000 V | V off | 00.0000V |
| Rise Rate | 3.000 A/us | Fall Rate | 3.000 A/us |
| Von Delay | 0.000 S | Power Source | CC |
| V Slew | 3.000 V/ms | Default | ----- |
| LOW | | HIGH | |

Figure 4.2 System Setting Page

| System Setting (SYSTEM) | | |
|-------------------------|--|---------------------------|
| V-Range | LOW | low voltage range 0~15.2V |
| | HIGH | high voltage range 0~152V |
| I-Range | LOW | low current range 0~3.2A |
| | HIGH | high current range 0~32A |
| I-Prot | Exceed the set value of 0.0002~32A, load protection | |
| P-Prot | Exceed the set value of 0.001~155W, load protection | |
| Von | Set 0V means the function is off. | |
| | Set 0~152V means Von function is on. | |
| Voff | Set 0V means the function is off. | |
| | Set 0~152V means Von function is on. | |
| Rise Rate | Set current rise rate of 0.001~3A/uS | |
| Fall Rate | Set current fall rate of 0.001~3A/uS | |
| Von Delay | Set Von delay time from 0 to 9.999S | |
| V Slew | Set 0.001V/mS | |
| Power Supply | AUTO, automatic detection of power supply type | |
| | CC, constant current power supply such as: LED power supply | |
| | CV, constant voltage power supply such as: most switching power supply | |
| Default | Restore factory settings and delete all user settings | |

4.1.1 Von/Voff Function

When user is testing some power products which voltage rise slowly, and the E-load have loaded before power products is power-up, the power product may latch protection. In this case, you'd better set Von on. Then E-load will load when power voltage is higher than this value by setting VON value.

| | |
|---|--|
|  NOTE | <p>Please confirm the necessity of setting loading voltage, this step provides convenience for limiting working voltage value of the source under test. If no necessary, don't set the loading voltage without authorization to prevent unnecessary trouble from failure of loading.</p> |
|---|--|

The user can set the Von voltage value under the System setting page to control the ON/OFF state of the E-load. If the instrument cannot load, please firstly check whether the VON function is on. If yes, reset the Von value to minimum value (which may be directly set as 0. If minimum voltage value of instrument is not 0, press 0 for confirmation and the menu will automatically set the value as minimum value).

When VON LATCH function is on, the E-load starts load only when the power voltage rises and is higher than Von Point loading voltage. When the power voltage drops and is lower than Von Point unloading voltage, the load will not unload, as shown in the figure below:

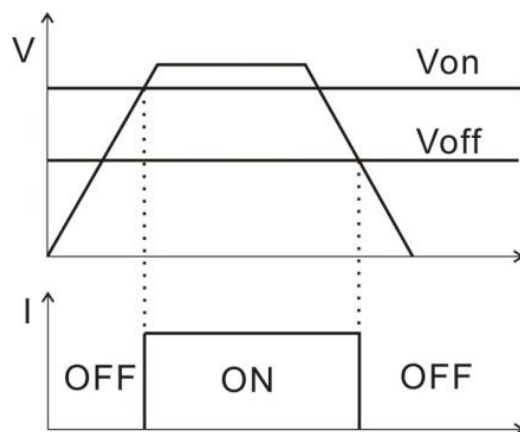
Figure 4.3 V_{on} 、 V_{off}

If V_{on} -Delay parameter is set, the E-load will load, when the source voltage reached V_{on} and have delayed for V_{on} -Delay time.

4.1.2 Source Type Selection Function

The E-load has the function of automatically detecting the type of source under test. But in some special cases, the source loaded doesn't meet your expectations. you can set the corresponding parameters manually according to your source type, and the E-load will load it according to the type of source you selected.

In MENU page, select the SYSTEM item and press the key to enter the parameter setting page. Select the source type under test.

4.2 Configuration

In MENU page, select the item CONFIG and press the key to enter the parameter setting page, as shown below.



| CONFIG | | | |
|---------------|---|--------------|---|
| Measure SET | | | |
| Rate | FAST | Remote Sense | OFF |
| Key Sound | OFF | Language | CN |
| Shortcut Call | OFF | | |
| Com Set | | | |
| COM Mode | RS232 | Baud | 9600 |
| Protocol | SCPI | Address | 01 |
| Multi | OFF | | |
| OUTPUT | | | |
| Out Mode | LEVE | Condition | PASS |
| Fail Op | Conti | | |
| COLOR | | | |
| Win Color |  | Back Color |  |

Figure 4.4 Configuration Page

| Configuration setting | | |
|-----------------------|-------|--|
| MEASURE SET | | |
| Rate | Fast | Real-time display and loading test |
| | Slow | Display and loading test after multiple sampling |
| Remote sense | OFF | Remote sense function OFF |
| | ON | Remote sense function ON |
| Key sound | OFF | Key sound function OFF |
| | ON | Key sound function ON |
| Language | EN | In English |
| | CN | In Chinese |
| Shortcut Call | OFF | Shortcut call function OFF |
| | ON | Shortcut call function ON |
| Communication Set | | |
| Communication Mode | RS232 | RS232 Communication |
| | RS485 | RS485 Communication |

| | | |
|---------------------------|--|---------------|
| Baud Rate | 9600 | |
| | 19200 | |
| | 38400 | |
| | 57600 | |
| Protocol | SCPI | SCPI protocol |
| Address | Address range from 1~99 | |
| Multi loads communication | ON: One interface and address bit controls multiple E-loads | |
| | OFF: Multiple interfaces control multiple E-loads | |
| OUTPUT | | |
| Output Mode | LEVEL- high level as default, low level when there is an output | |
| | PLUSE-high level as default, output 5mS pulse when the test result is qualified; output 10mS pulse when the test result is unqualified | |
| Condition | Qualified-output when the test is qualified | |
| | Failed- output when the test is failed | |
| | End: output when the test ended | |
| | Closed-no output | |
| Fail Op. | Continue: continue testing when it fails | |
| | Stop: stop testing when it fails | |
| COLOR | | |
| WIN | Green-font Green | |
| | Yellow-font yellow | |
| | Blue-font blue | |
| Back Color | Light gray-light gray background | |
| | Dark gray- dark gray background | |
| | Black-black background | |

4.2.1 Remote Sense Compensation Mode

If the E-load consumes large current, a large voltage drop will be detected in connection line between tested instrument and E-load terminal. To ensure measurement accuracy, a remote sense measurement terminal is provided at E-load rear board to compensate voltage drop lost in wire. Operation steps as below:

1. Press  to enter the parameter setting interface;
2. Move the cursor to the test setting - the remote compensation sense
3. Select ON/OFF to turn on/off remote sense function. Status bar shows REMOTE when the

remote sense function is ON.

| CONFIG | | | |
|---------------|-------|--------------|------|
| Measure SET | | | |
| Rate | FAST | Remote Sense | OFF |
| Key Sound | OFF | Language | CN |
| Shortcut Call | OFF | | |
| Com Set | | | |
| COM Mode | RS232 | Baud | 9600 |
| OFF | | ON | |

Figure 4.5 Remote Sense Setting Page

Remote measurement access, please refer to the figure as below.

Wiring Diagram of Remote Sense:

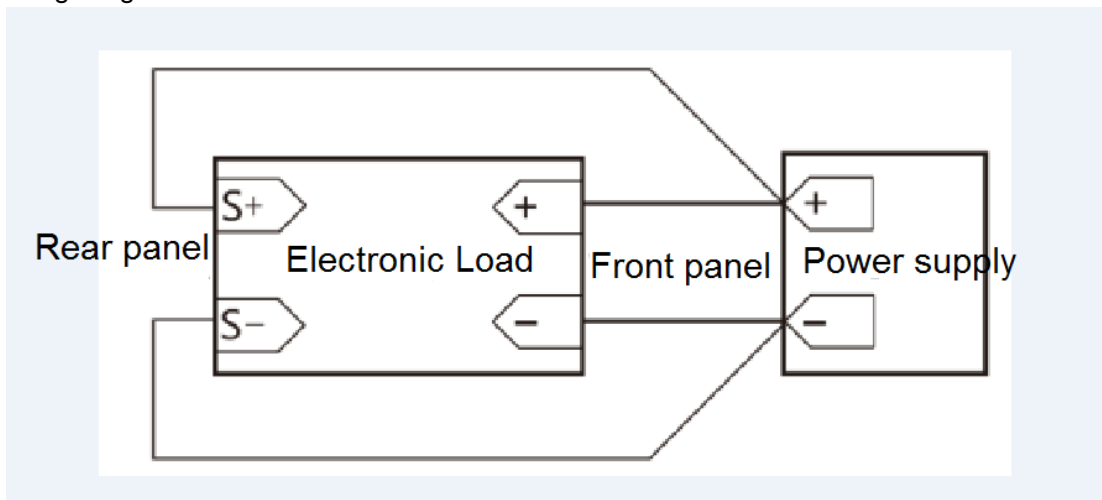



Figure 4.6 Remote-Sense wiring Diagram

| | |
|---|--|
|  | <p>NOTE</p> <p>If the remote compensation started, the wiring must be the same as above, otherwise the voltage detection function will be fail. The REMOTE prompt will be displayed in the status bar of the display.</p> |
|---|--|

4.2.2 Shortcut Call Mode

The E-load provides the Shortcut Call function. After the function is enabled, the user can quickly call up the 10

sets of setup parameters stored in the SAVE (see 4.3) function by directly pressing the 0~9 number keys.

| | |
|---|---|
|  NOTE | If the Shortcut Call is enabled, the digital 0~9 keys will change the original function, only the calling function is retained, and the display status bar will display SHORTCUT. When Shortcut Call is turned off, the numeric keys will return to normal. |
|---|---|

4.2.3 Trigger Output Settings

The E-load has a TRO signal output port at the rear panel. In the auto mode and over-current protection mode, when an output signal is required, you can program the output signal, output condition, and the action after the test failed.

For example: set the output mode to Level, the output condition to Qualified and failed action to Stop.

The TRO port level will change from high to low when the test is qualified, and will remain the status until the next test begins. If a failure is encountered, the output is always high and the test is stopped.

For more specific settings, refer to **Chapter 4.2 Parameter Settings - Output** and **Chapter 6.1 I/O Port Settings**.

4.3 Save/Recall Function

The E-load can save parameters and working-mode up to 10 groups for convenient and fast usage. For example, first set load parameters in CC mode, set the range under MENU, and go to the SAVE for storage, the SAVE is as follows:

| SAVE | |
|----------------|---------------|
| Save operation | |
| NO. | Name |
| 01 | PANEL _ 01 |
| 02 | PANEL _ 02 |
| 03 | PANEL _ 03 |
| 04 | PANEL _ 04 |
| 05 | PANEL _ 05 |
| Mode | CC |
| Voltage range | HIGH |
| Current range | LOW |
| Loading value | 01.0000 |
| SAVE | LOAD |
| CLEAR | RENAME |

Figure 4.7 Save Setting Page

Press the key **SAVE** to save above settings to the file 1 where the cursor is located, and rename it as needed. If you need to call a saved test file, there are two ways:

1. Press the key **MENU** to go to the setting page and select **Save**, then select the desired file and press the key **Loading** to call the stored test mode.

2, the E-load provides a quick call function, that is,

In **Menu** page, select the item **CONFIG-TEST SETTING-SHORTCUT CALL**, as shown in Figure 4.8, after the shortcut call enabled, you can directly use the 0~9 number keys to call the test file in the **SAVE**. 1~9 corresponds to file No.1~9, and 0 corresponds to file No.10. At this time, the number key has only a shortcut call function and no data input function. If you need to restore the data input function, you can close the shortcut call. As shown below:

| CONFIG | | | |
|---------------|-------|--------------|------|
| Measure SET | | | |
| Rate | FAST | Remote Sense | OFF |
| Key Sound | OFF | Language | CN |
| Shortcut Call | OFF | | |
| Com Set | | | |
| COM Mode | RS232 | Baud | 9600 |

OFF ON

Figure 4.8 Shortcut Cal Setting Page

Chapter 5 Protection Function

The E-load is provided with following protective functions:

1. overvoltage protection (OVP),
2. over-current protection (OCP),
3. over-power protection (OPP),
4. over-temperature protection (OTP)
5. input voltage reverse protection (RV)

If any one of the above protections is enabled, the E-load will have corresponding actions. Press any key on the front board to reset protection functions. For example, in case of over-temperature protection, the E-load will give alarm and the input will automatically switch to OFF status. The E-load LCD will display OTP and the WARNING indicator lights up.

5.1 Over-voltage protection (OVP)

The E-load provides overvoltage protection. When the input voltage is higher than 110% of the rated voltage, the E-load will display "OVER VOLT", the E-load will be immediately OFF and the buzzer will sound. Press any key to cancel the beeper.

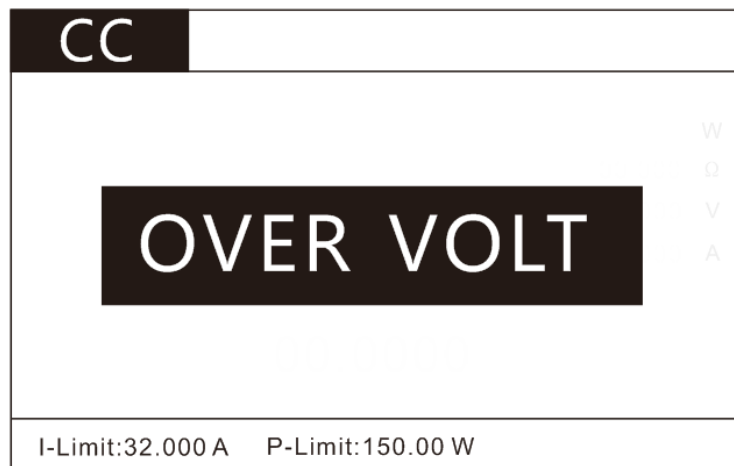

Figure 5.1 OVP Page

5.2 Over-current protection (OCP)

The E-load provides over-current protection. When the input current is higher than the setting current(See Chapter 4.1 - System Settings - Current Protection), the E-load will display "OVER CURR", the E-load will be immediately OFF and the buzzer will sound. Press any key to cancel the beeper.

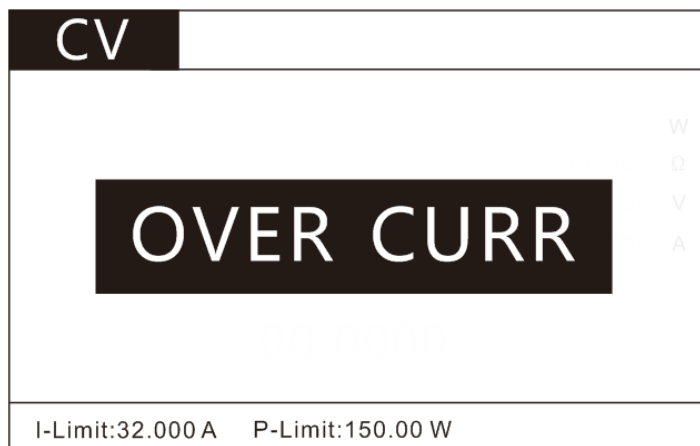

Figure 5.2 OCP Page

5.3 Over-power protection (OVP)

The E-load provides over-power protection. When the input power is higher than the setting power (See Chapter 4.1 - System Settings - Power Protection), the E-load will display "OVER POW", the E-load will be immediately OFF and the buzzer will sound. Press any key to cancel the beeper.

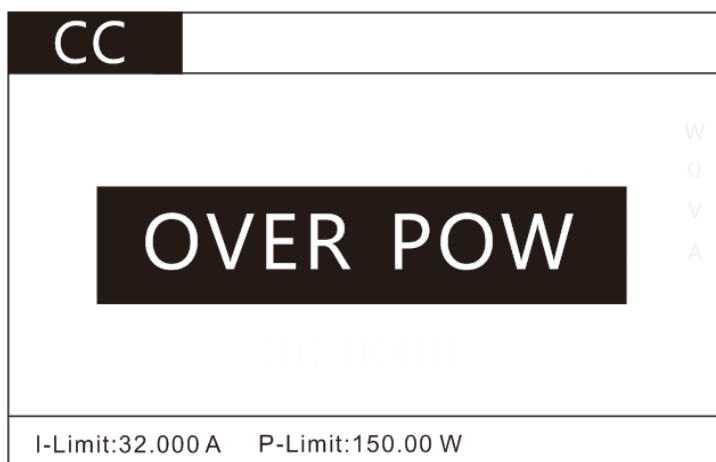

Figure 5.3 OPP Page

5.4 Over-temperature protection (OTP)

When internal temperature higher than 80 °C, the E-load will enter the state of temperature protection and LCD will display "OVER TEMP". At this time, the E-load will

automatically be OFF and the buzzer will sound. Press any key to cancel the beeper.

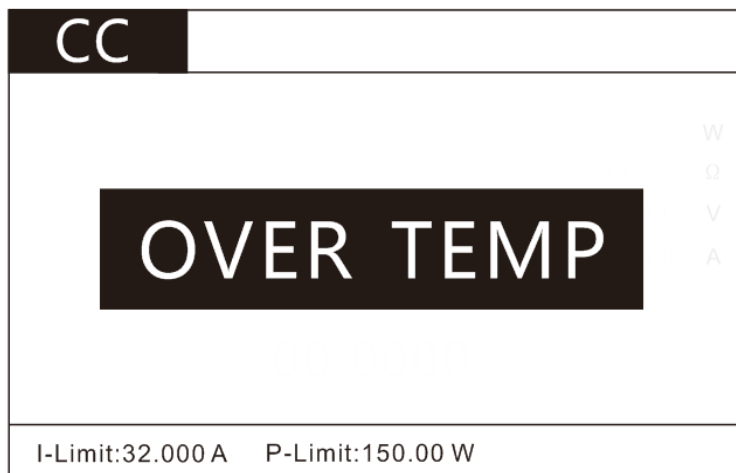

Figure 5.4 OTP Page

5.5 Input Voltage Reverse Protection (RV)

When the polarity of the input voltage is reversed, the E-load will display" REVERSE", the E-load will be immediately OFF and the buzzer will sound. until the wiring is disconnected, press any key to cancel the beeper.

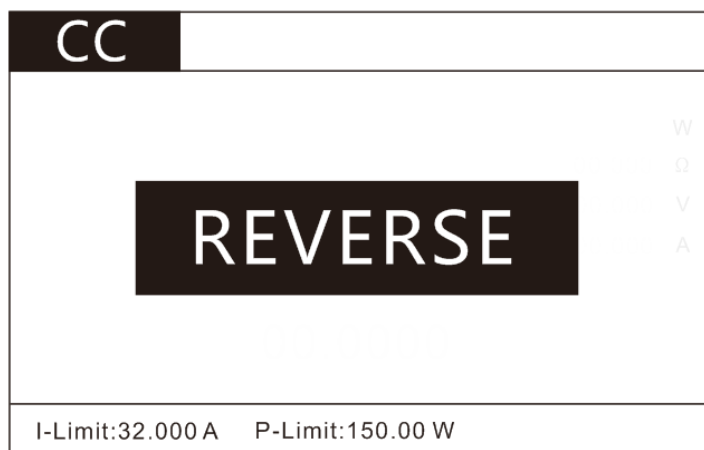

Figure 5.5 Input Voltage Reverse Protection Page

Chapter 6 I/O Interface

The E-load provides I/O interface, which is convenient for the user to connect the external control signal output and other control units to complete the automatic test.

6.1 I/O Interface



Figure 6.1:I/O interface

1, EXV: external power supply interface

2, GND: ground

3, EOC: test completion signal output

4, TRO: trigger signal output port

5, TRI: trigger signal input port

6.2 I/O Interface Function

The port circuit diagram is as follows:

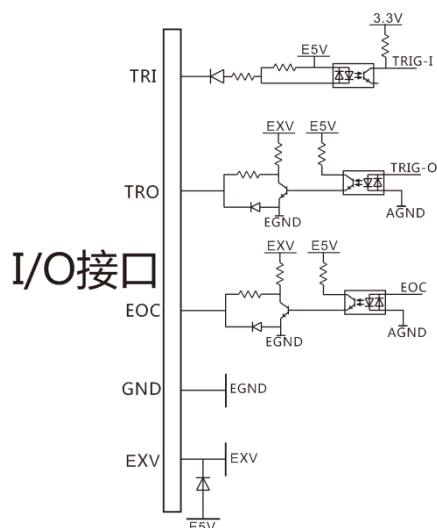

1. The EXV port is an external power supply input port. It can be accessed when the user-specified voltage is required. When the external voltage is not connected, the internal isolation E5V is supplied.
2. GND is the isolated power ground.
3. The EOC port is the test completion signal. EOC is high level during the test and waiting for the test. After the test completes EOC outputs low level.
4. The TRO is the trigger output port. In the modes like AUTO, OCP, which needs to judge, the output mode can be set to output the signal required by the user for the user to connect to other devices. For specific settings, please refer to the parameter settings in Chapter 4.2 - Output.
5. The TRI is the trigger input port. When the TRI port is connected to the low level (short-circuited with GND), the test can be started or ended. In the STEP mode of LIST and the Toggle in DYNA mode , the TRI port has the same function to .

Chapter 7 Specifications

We use FS (full scale) to define measurement tolerances.

FS: Maximum display value or measurement range.

7.1 Main Specifications

| Model | HT8322 | | HT8322B | | HT8322C | | HT8322D | |
|--------------------------------------|-----------------------------|------|-----------------------------|------|-----------------------------|------|-----------------------------|------|
| Input voltage | 15V | 150V | 50V | 500V | 15V | 150V | 50V | 500V |
| Input current | 24A | 240A | 12A | 120A | 50A | 500A | 24A | 240A |
| Input power | 3200W | | | | | | | |
| Mini. operating voltage | 1V@240A | | 4.5V@120A | | 1.5V@500A | | 9V@240A | |
| Min. rise time at full-scale current | 60us | | | | | | | |
| CV mode | | | | | | | | |
| Range | 15V | 150V | 50V | 500V | 15V | 150V | 50V | 500V |
| Resolution | 0.2mV | 2mV | 0.7mV | 7mV | 0.2mV | 2mV | 0.7mV | 7mV |
| Accuracy | $\pm(0.05\%+0.025\%FS)$ | | | | | | | |
| CC mode | | | | | | | | |
| Range | 24A | 240A | 12A | 120A | 50A | 500A | 24A | 240A |
| Resolution | 0.3mA | 3mA | 0.1mA | 1mA | 0.7mA | 7mA | 0.3mA | 3mA |
| Accuracy | $\pm(0.1\%+0.1\%FS)$ | | | | | | | |
| CR mode | | | | | | | | |
| Range | 0.1 Ω ~7.5k Ω | | 0.1 Ω ~7.5k Ω | | 0.1 Ω ~7.5k Ω | | 0.1 Ω ~7.5k Ω | |
| Resolution | 16Bits | | | | | | | |
| Accuracy | $\pm 0.1\%$ | | | | | | | |
| CW mode | | | | | | | | |
| Range | 3200W | | | | | | | |
| Resolution | 16Bits | | | | | | | |
| Accuracy | $\pm (0.2\%+0.2\%FS)$ | | | | | | | |
| Dynamic mode | | | | | | | | |
| Ta & Tb | 10uS~50s | | | | | | | |
| Minimum resolution | 10us | | | | | | | |
| Maximum up/down slope | 2.5A/us | | 0.8A/us | | 2.5A/us | | 0.8A/us | |
| Read-back voltage | | | | | | | | |

| | | | | | | | | |
|--------------------------------|--------------------------------|------|-------|------|-------|------|--------|-------|
| Range | 15V | 150V | 50V | 500V | 15V | 150V | 50V | 500V |
| Resolution | 0.1mV | 1mV | 0.3mV | 3mV | 0.1mV | 1mV | 0.3mV | 3mV |
| Accuracy | $\pm(0.025\%+0.025\%FS)$ | | | | | | | |
| Read-back current | | | | | | | | |
| Range | 24A | 240A | 12A | 120A | 50A | 500A | 24A | 240A |
| Resolution | 0.1mA | 1mA | 0.1mA | 1mA | 0.1mA | 1mA | 0.09mA | 0.9mA |
| Accuracy | $\pm(0.1\%+0.1\%FS)$ | | | | | | | |
| Read-back Ripple | | | | | | | | |
| Range (R/I) | 500V/120A | | | | | | | |
| bandwidth | 10Hz~250kHz | | | | | | | |
| Accuracy | $\pm 1\%$ | | | | | | | |
| Protection range | | | | | | | | |
| Overpower protection | 3360W | | | | | | | |
| Overcurrent protection | 252A | 126A | 252A | 126A | | | | |
| Overvoltage protection | 158V | 525V | 158V | 525V | | | | |
| Over-temperature protection | $\approx 85^{\circ}C$ | | | | | | | |
| Specification | | | | | | | | |
| Size (length * width * height) | 620mm*464mm*174mm (no legs) | | | | | | | |
| Weight (Kg) | 38Kg | | | | | | | |

Chapter 8 Communication Interfaces

This chapter mainly introduces the communication mode, method, and protocol of the HT8XXX series E-load.

8.1 Communication module

HT8XXX series E-load is provided with three communication interfaces to communicate with a computer for selection, including RS232, RS485 and LAN.

Press any key  on any work interface to enter the parameter setting interface;

Press the left or right button to move the cursor to the communication mode box under the communication setting bar;

Select the RS232/RS485/LAN communication mode at the bottom of the screen.

8.2 DB9

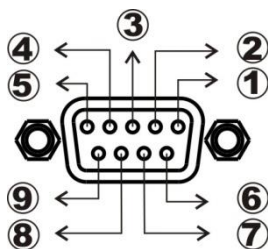

Figure 6.1 DB9 pins of plug

①.GND

②.RS232-TXD

③.RS232-RXD

④.NC

⑤.GND

⑥.NC

⑦.NC

⑧.485A

⑨.485B

8.3 Protocol

The HT8XXX series of E-loads supports SCPI protocol. Its data frame structure consists of four parts:

Set the additional address

(to be set only when multi-machine communication is on)

- i. Press the key  on any working interface to enter the parameter setting interface;
- ii. Press the left or right button to move the cursor to the address box under the Communication setting bar;
- iii. Press the number keys to edit. After editing, press ENTER to confirm the operation. Please note that this address should be an integer between 0 and 99.

Select the Baud rate

- i. Press the key  on any working interface to enter the parameter setting interface;
- ii. Press the left or right button to move the cursor to the address box under the Baud rate setting bar
- iii. Select the baud rate you want. At present, the E-load only supports 9600, 19200, 38400 and 57600.

8.4 SCPI Communication Instruction

- 1 *IDN?
Meaning: Query version number
Return: 88115, V1.0
Example: query version number
Send: *IDN?
Back: 8182,V1.0

- 2 *TRG
Meaning: Trigger test, no return
Example: Trigger test
Send: *TRG
Back: no

- 3 INPut
Meaning: input on or off, 0 off 1 on
Example: Input on
Send: INPut 1
Back: no

- 4 CURRent:RANGe
Meaning: set current range LOW/HIGH 0/1
Example: set low current range
Send: CURRent: RANGe 0
Back: no

- 5 VOLTage:RANGe
Meaning: set the voltage range LOW/HIGH(0/1)
Example: set the voltage range to LOW
Send: VOLTage: RANGe 0
Back: no

- 6 CURRent:SLEW
Meaning: set current rise time and fall time
Example: set the current rise/fall time to 3A/uS
Send: CURRent: SLEW 3
Back: no

- 7 CURRent:SLEW:RISE
Meaning: set current rise time
Example: set current rise time 3A/uS
Send: CURRent: SLEW: RISE 3
Back: no

- 8 CURRent:SLEW:FALL
 Meaning: set current fall time
 Example: set current fall time 3A/uS
 Send: CURRent: SLEW: RISE 3
 Back: no
- 9 CURRent:PROTection
 Meaning: set current protection value
 Example: set current protection value to 3A/uS
 Send: CURRent: PROTection 3
 Back: no
- 10 POWer: PROTection
 Meaning: set power protection value
 Example: set power protection value to 150W.
 Send: POWer: PROTection 150
 Back: no
- 11 VOLTage:ON
 Meaning: set Von value
 Example: set the start voltage value to 10V
 Send: VOLTage: ON 10
 Back: no
- 12 VOLTage:OFF
 Meaning: set the Voff value
 Example: set the shutdown voltage value to 5V
 Send: VOLTage: OFF 5
 Back: no
- 13 MODE
 Meaning: set working mode
 Example: set CC mode
 Send: MODE CURRent
 Back: no

| Parameter | Working mode |
|------------|--------------|
| CURRent | CC mode |
| VOLTage | CV mode |
| POWer | CP mode |
| RESistance | CR mode |
| DYNAmic | Dynamic mode |
| LED | LED mode |
| OCP | OCP mode |

| | |
|--------|-----------------|
| LIST | LIST mode |
| SHORT | SHORT mode |
| SWEEP | SWEEP mode |
| TIMing | TIMing function |
| AUTO | AUTO mode |
| EFFT | EFFT mode |

14 CURRent

Meaning: set the current value in CC mode

Example: set the CC working mode current to 1A

Send: CURRent 1

Back: no

15 VOLTage

Meaning: set the voltage value in CV mode

Example: Set the CV working mode voltage to 10V

Send: VOLTage 10

Back: no

16 POWer

Meaning: set the power value in CW mode

Example: Set the CW working mode voltage to 100W

Send: POWer 100

Back: no

17 RESistance

Meaning: set the resistance value in CR mode

Example: Set the CR working mode voltage to 1000Ω

Send: RESistance 1000

Back: no

18 MEASure:VOLTage?

Meaning: read measured voltage value

Example: read measured voltage value

Send: MEASure:VOLTage?

Returns: 00.0000

19 MEASure:CURRent?

Meaning: read measured current value

Example: read measured current value

Send: MEASure: CURRent?

Returns: 00.0000

- 20 MEASure:POWer?
Meaning: read measured power value
Example: read measured power value

Send: MEASure: POWer?

Returns: 00.000
- 21 MEASure:RESistance?
Meaning: read measured resistance value
Example: read measured resistance value
Send: MEASure: RESistance?
Returns: 00.0000
- 22 CURRent:RANGe?
Meaning: read the current range
Example: read the current range
Send: CURRent:RANGe?
Returns: 0, 1
- 23 VOLTage:RANGe?
Meaning: read the voltage range
Example: read the voltage range
Send: VOLTage:RANGe?
Returns: 0, 1
- 24 CURRent:SLEW:RISE?
Meaning: read the current rise time
Example: read the current rise time
Send: CURRent:SLEW:RISE?
Returns: 00.0000
- 25 CURRent:SLEW:FALL?
Meaning: read the current fall time
Example: read the current fall time
Send: CURRent:SLEW:FALL?
Returns: 00.0000
- 26 CURRent:PROTection?
Meaning: read the current protection value
Example: read the current t protection value
Send: CURRent:PROTection?
Returns: 00.0000
- 27 POWer:PROTection?
Meaning: read the power protection value

Example: read the power protection value

Send: POWer:PROTection?

Returns: 00.0000

28 DYNamic:HIGH

Meaning: set high level loading current in dynamic mode

Example: set high level loading current at 3A in dynamic mode

Send: DYNamic:HIGH 3

Back: no

29 DYNamic:HIGH:DWELI

Meaning: set the duration for high level loading current in dynamic mode
Example: set the duration 5mS for high level loading current in dynamic mode

Send: DYNamic:HIGH:DWELI 5

Back: no

30 DYNamic:LOW

Meaning: set low level loading current in dynamic mode

Example: set low level loading current at 3A in dynamic mode

Send: DYNamic:LOW 1A

Back: no

31 DYNamic:LOW:DWELI

Meaning: set the duration for low level loading current in dynamic mode
Example: set low level loading current at 5A in dynamic mode

Send: DYNamic: LOW: DWELI 5

Back: no